

Description

The HM90N02D uses advanced trench technology and design to provide excellent $R_{DS(ON)}$ with low gate charge. It can be used in a wide variety of applications.

General Features

- $V_{DS} = 20V, I_D = 90A$
 $R_{DS(ON)} < 2.6m\Omega @ V_{GS} = 4.5V$
- High density cell design for ultra low R_{dson}
- Fully characterized avalanche voltage and current
- Good stability and uniformity with high E_{AS}
- Excellent package for good heat dissipation

Application

- Load switching
- Hard switched and high frequency circuits
- Uninterruptible power supply

100% UIS TESTED!

100% ΔV_{ds} TESTED!

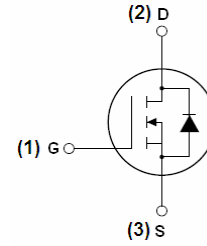

Schematic diagram

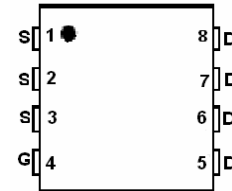

Marking and pin assignment

Package Marking and Ordering Information

Device Marking	Device	Device Package	Reel Size	Tape width	Quantity
HM90N02D	HM90N02D	DFN5X6-8	-	-	-

Absolute Maximum Ratings ($T_C = 25^\circ C$ unless otherwise noted)

Parameter	Symbol	Limit	Unit
Drain-Source Voltage	V_{DS}	20	V
Gate-Source Voltage	V_{GS}	± 12	V
Drain Current-Continuous	I_D	90	A
Drain Current-Continuous($T_C = 100^\circ C$)	$I_D(100^\circ C)$	63	A
Pulsed Drain Current	I_{DM}	270	A
Maximum Power Dissipation	P_D	60	W
Derating factor		0.48	W/ $^\circ C$
Single pulse avalanche energy ^(Note 5)	E_{AS}	200	mJ
Operating Junction and Storage Temperature Range	T_J, T_{STG}	-55 To 150	$^\circ C$

Thermal Characteristic

Thermal Resistance, Junction-to-Case ^(Note 2)	$R_{\theta JC}$	2.1	$^\circ C/W$
--	-----------------	-----	--------------

Electrical Characteristics (T_C=25°C unless otherwise noted)

Parameter	Symbol	Condition	Min	Typ	Max	Unit
Off Characteristics						
Drain-Source Breakdown Voltage	BV _{DSS}	V _{GS} =0V I _D =250μA	20	25	-	V
Zero Gate Voltage Drain Current	I _{DSS}	V _{DS} =20V, V _{GS} =0V	-	-	1	μA
Gate-Body Leakage Current	I _{GSS}	V _{GS} =±12V, V _{DS} =0V	-	-	±100	nA
On Characteristics (Note 3)						
Gate Threshold Voltage	V _{GS(th)}	V _{DS} =V _{GS} , I _D =250μA	1.0		2.5	V
Drain-Source On-State Resistance	R _{DS(ON)}	V _{GS} =4.5V, I _D =20 A	-		2.6	mΩ
		V _{GS} =10V, I _D =15A			2.3	mΩ
Forward Transconductance	g _{FS}	V _{DS} =10V, I _D =20A	15	-	-	S
Dynamic Characteristics (Note4)						
Input Capacitance	C _{iss}	V _{DS} =10V, V _{GS} =0V, F=1.0MHz	-	2000	-	PF
Output Capacitance	C _{oss}		-	500	-	PF
Reverse Transfer Capacitance	C _{rss}		-	200	-	PF
Switching Characteristics (Note 4)						
Turn-on Delay Time	t _{d(on)}	V _{DD} =10V, I _D =2A, R _L =1Ω V _{GS} =4.5V, R _G =3Ω	-	6.4	-	nS
Turn-on Rise Time	t _r		-	17.2	-	nS
Turn-Off Delay Time	t _{d(off)}		-	29.6	-	nS
Turn-Off Fall Time	t _f		-	16.8	-	nS
Total Gate Charge	Q _g	V _{DS} =10V, I _D =20A, V _{GS} =10V	-	27		nC
Gate-Source Charge	Q _{gs}		-	6.5		nC
Gate-Drain Charge	Q _{gd}		-	6.4		nC
Drain-Source Diode Characteristics						
Diode Forward Voltage (Note 3)	V _{SD}	V _{GS} =0V, I _S =10A	-		1.2	V
Diode Forward Current (Note 2)	I _S		-	-	90	A
Reverse Recovery Time	t _{rr}	T _J = 25°C, I _F = 20A di/dt = 100A/μs (Note3)	-	25	-	nS
Reverse Recovery Charge	Q _{rr}		-	24	-	nC
Forward Turn-On Time	t _{on}	Intrinsic turn-on time is negligible (turn-on is dominated by LS+LD)				

Notes:

1. Repetitive Rating: Pulse width limited by maximum junction temperature.
2. Surface Mounted on FR4 Board, t ≤ 10 sec.
3. Pulse Test: Pulse Width ≤ 300μs, Duty Cycle ≤ 2%.
4. Guaranteed by design, not subject to production
5. E_{AS} condition : T_J=25°C, V_{DD}=10V, V_G=10V, L=0.5mH, R_g=25Ω.

Test circuit

1) E_{AS} Test Circuit

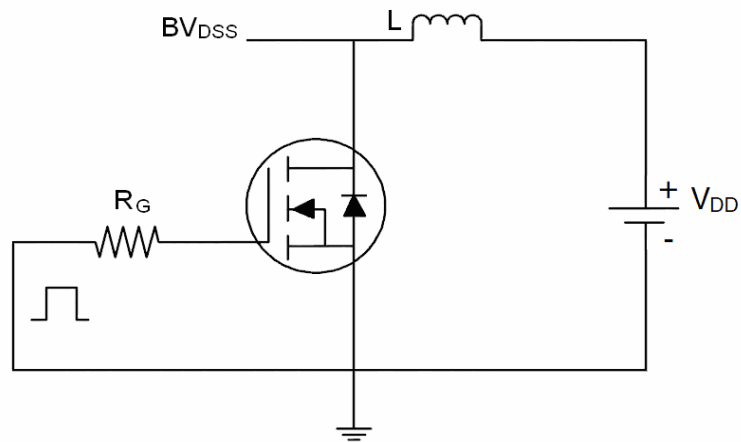

2) Gate Charge Test Circuit

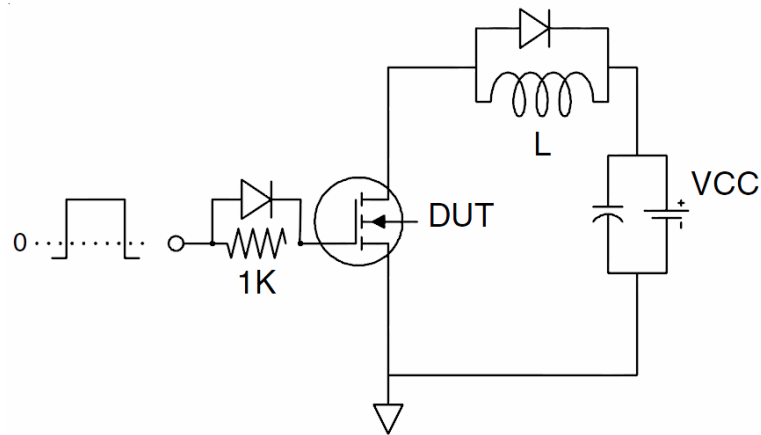

3) Switch Time Test Circuit

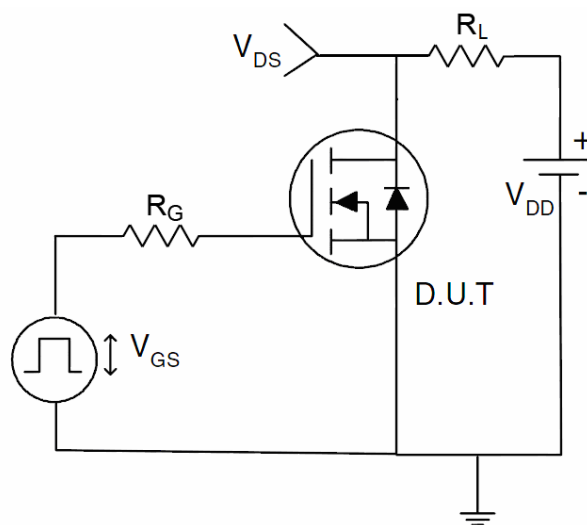

Typical Electrical and Thermal Characteristics (Curves)

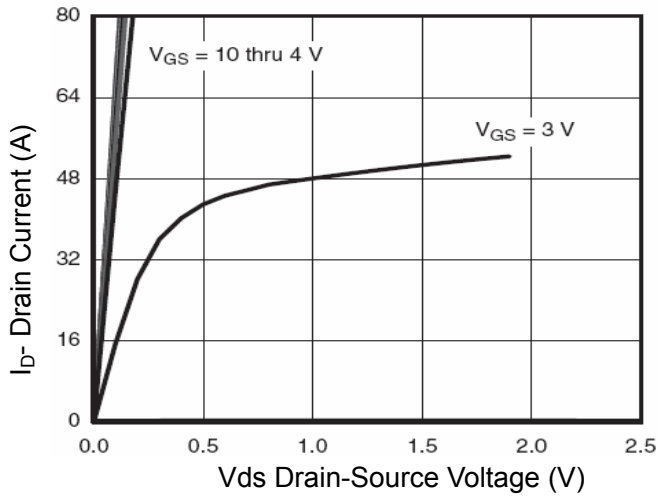

Figure 1 Output Characteristics

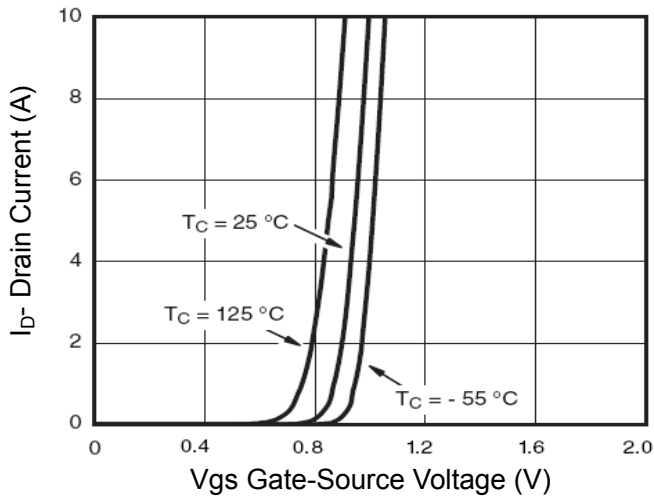

Figure 2 Transfer Characteristics

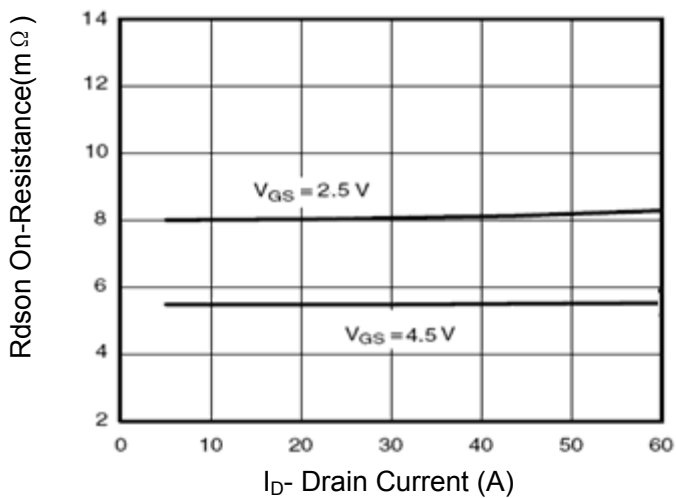

Figure 3 Rdson- Drain Current

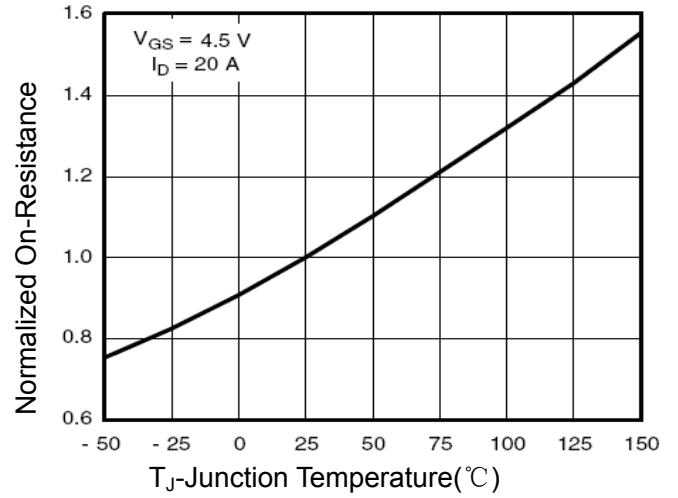

Figure 4 Rdson-Junction Temperature

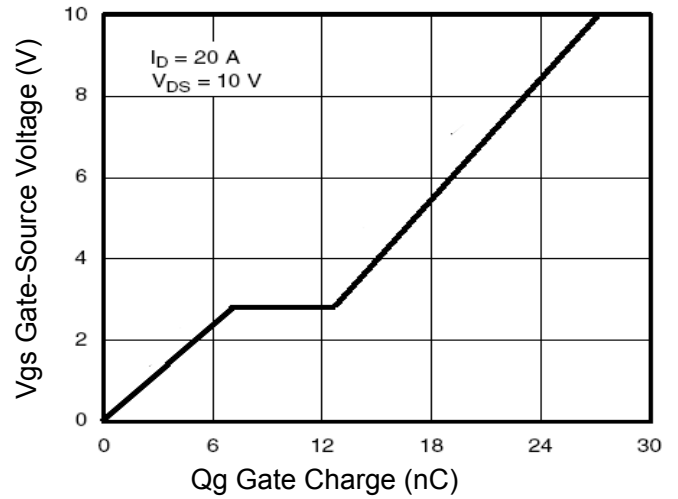

Figure 5 Gate Charge

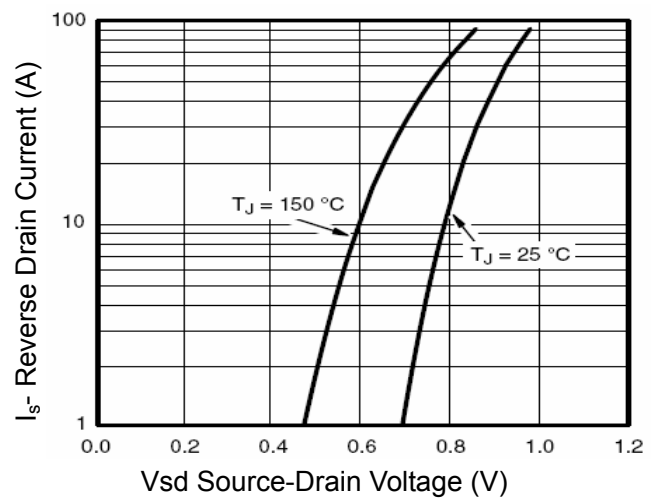

Figure 6 Source- Drain Diode Forward

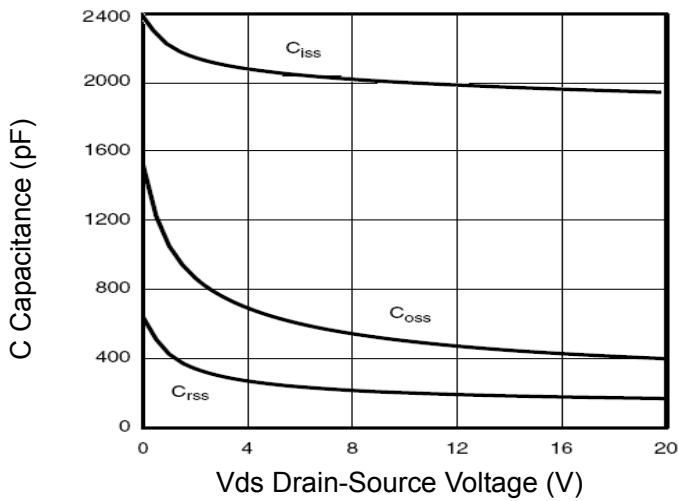

Figure 7 Capacitance vs Vds

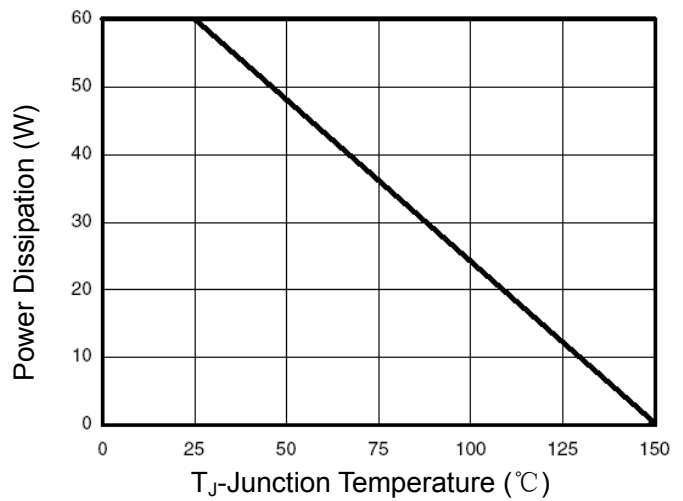

Figure 9 Power De-rating

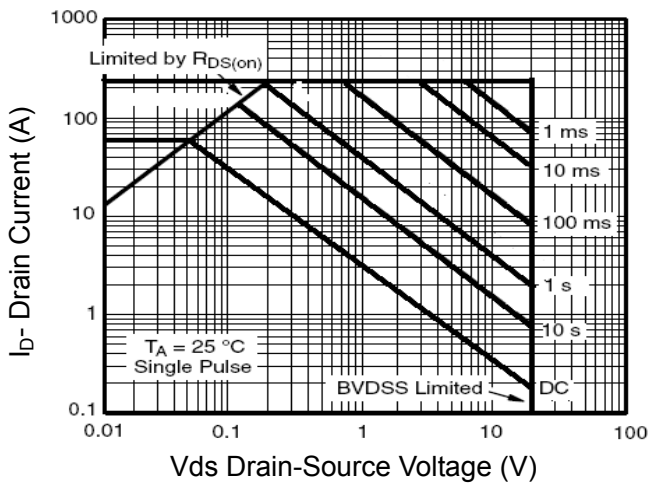

Figure 8 Safe Operation Area

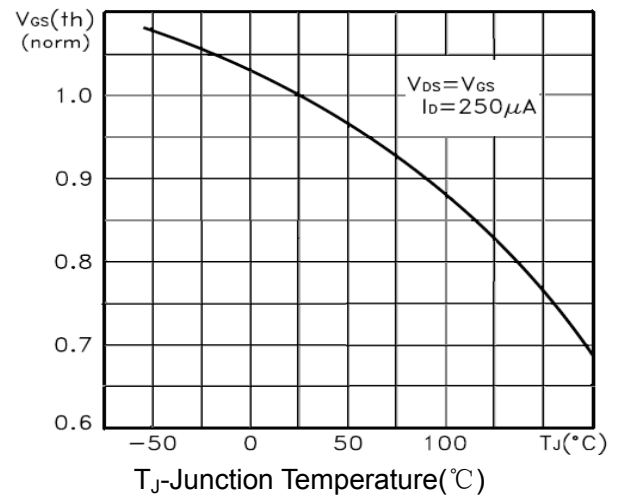

Figure 10 $V_{GS(th)}$ vs Junction Temperature

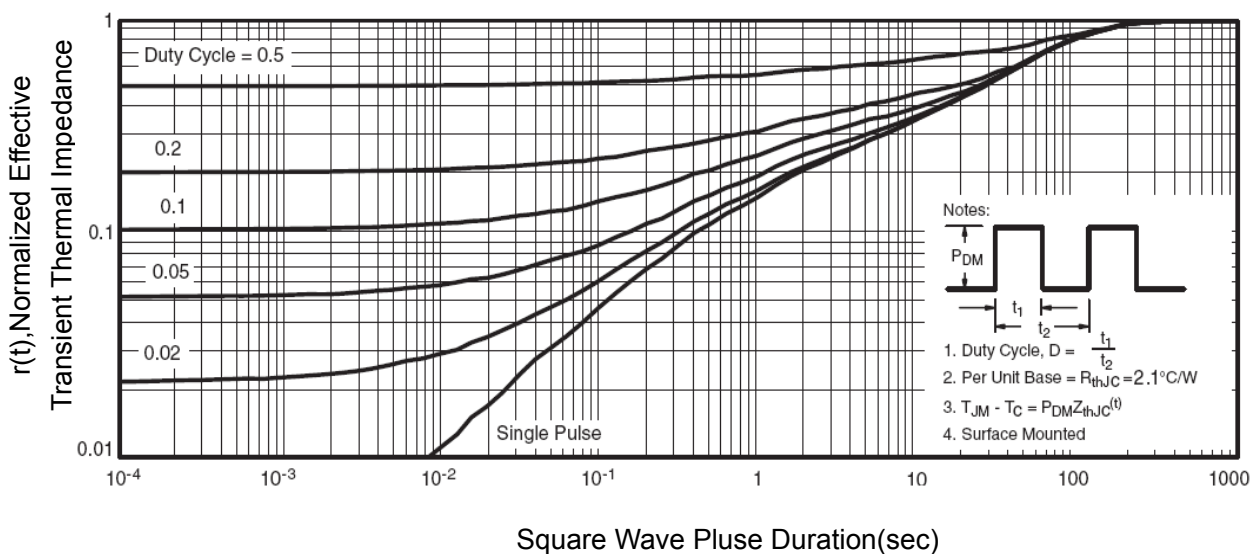
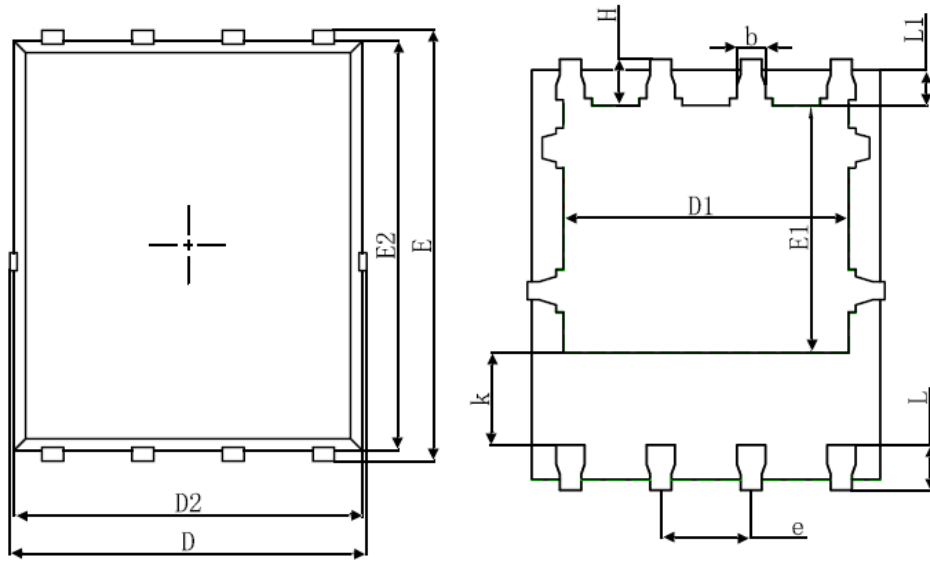

Figure 11 Normalized Maximum Transient Thermal Impedance

DFN5X6-8L Package Information



Top View
[顶视图]

Bottom View
[背视图]

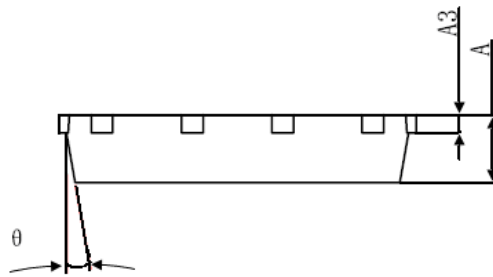

Side View
[侧视图]

Symbol	Dimensions In Millimeters		Dimensions In Inches	
	Min.	Max.	Min.	Max.
A	0.900	1.000	0.035	0.039
A3	0.254REF.		0.010REF.	
D	4.944	5.096	0.195	0.201
E	5.974	6.126	0.235	0.241
D1	3.910	4.110	0.154	0.162
E1	3.375	3.575	0.133	0.141
D2	4.824	4.976	0.190	0.196
E2	5.674	5.826	0.223	0.229
k	1.190	1.390	0.047	0.055
b	0.350	0.450	0.014	0.018
e	1.270TYP.		0.050TYP.	
L	0.559	0.711	0.022	0.028
L1	0.424	0.576	0.017	0.023
H	0.574	0.726	0.023	0.029
θ	8°	12°	8°	12°