

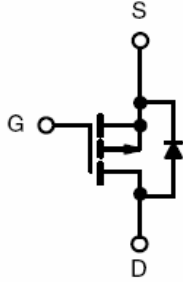

P-Channel Enhancement Mode Power MOSFET

<p>Description The HM60P06K uses advanced trench technology and design to provide excellent $R_{DS(ON)}$ with low gate charge .This device is well suited for high current load applications.</p> <p>General Features</p> <ul style="list-style-type: none"> ● $V_{DS} = -60V, I_D = -60A$ $R_{DS(ON)} < 17m\Omega @ V_{GS} = -10V$ ● High density cell design for ultra low R_{dson} ● Fully characterized avalanche voltage and current ● Good stability and uniformity with high E_{AS} ● Excellent package for good heat dissipation <p>Application</p> <ul style="list-style-type: none"> ● Load switch <p style="text-align: center; color: red; font-weight: bold; margin-top: 20px;">100% UIS TESTED!</p> <p style="text-align: center; color: red; font-weight: bold; margin-top: 10px;">100% ΔV_ds TESTED!</p>	 <p>Schematic diagram</p>  <p>Marking and pin assignment</p>  <p>TO-252-2L top view</p>
--	--

Package Marking and Ordering Information

Device Marking	Device	Device Package	Reel Size	Tape width	Quantity
HM60P06K	HM60P06K	TO-252-2L	-	-	-

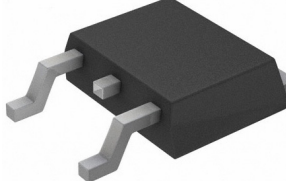
Absolute Maximum Ratings ($T_C=25^\circ C$ unless otherwise noted)

Parameter	Symbol	Limit	Unit
Drain-Source Voltage	V_{DS}	-60	V
Gate-Source Voltage	V_{GS}	± 20	V
Drain Current-Continuous	I_D	-60	A
Drain Current-Continuous($T_C=100^\circ C$)	$I_D(100^\circ C)$	-42	A
Pulsed Drain Current	I_{DM}	-180	A
Maximum Power Dissipation	P_D	95	W
Derating factor		0.76	W/ $^\circ C$
Single pulse avalanche energy ^(Note 5)	E_{AS}	722	mJ
Operating Junction and Storage Temperature Range	T_J, T_{STG}	-55 To 150	$^\circ C$

Thermal Characteristic

Thermal Resistance, Junction-to-Case ^(Note 2)	$R_{\theta JC}$	1.31	$^\circ C/W$
--	-----------------	------	--------------

Electrical Characteristics ($T_C=25^{\circ}\text{C}$ unless otherwise noted)

Parameter	Symbol	Condition	Min	Typ	Max	Unit
Off Characteristics						
Drain-Source Breakdown Voltage	BV_{DSS}	$V_{GS}=0V, I_D=-250\mu A$	-60	-	-	V
Zero Gate Voltage Drain Current	I_{DSS}	$V_{DS}=-60V, V_{GS}=0V$	-	-	-1	μA
Gate-Body Leakage Current	I_{GSS}	$V_{GS}=\pm 20V, V_{DS}=0V$	-	-	± 100	nA
On Characteristics (Note 3)						
Gate Threshold Voltage	$V_{GS(th)}$	$V_{DS}=V_{GS}, I_D=-250\mu A$	-1.€		-1€	V
Drain-Source On-State Resistance	$R_{DS(ON)}$	$V_{GS}=-10V, I_D=-17A$	-	-	17	m Ω
Forward Transconductance	g_{FS}	$V_{DS}=-10V, I_D=-10A$	-	25	-	S
Dynamic Characteristics (Note4)						
Input Capacitance	C_{ISS}	$V_{DS}=-25V, V_{GS}=0V,$ $F=1.0MHz$	-	6460	-	PF
Output Capacitance	C_{OSS}		-	719	-	PF
Reverse Transfer Capacitance	C_{RSS}		-	535	-	PF
Switching Characteristics (Note 4)						
Turn-on Delay Time	$t_{d(on)}$	$V_{DD}=-30V, R_L=1.5\Omega,$ $V_{GS}=-10V, R_G=3\Omega$	-	15	-	nS
Turn-on Rise Time	t_r		-	17	-	nS
Turn-Off Delay Time	$t_{d(off)}$		-	40	-	nS
Turn-Off Fall Time	t_f		-	45	-	nS
Total Gate Charge	Q_g	$V_{DS}=-30, I_D=-10A,$ $V_{GS}=-10V$	-	75		nC
Gate-Source Charge	Q_{gs}		-	16		nC
Gate-Drain Charge	Q_{gd}		-	19		nC
Drain-Source Diode Characteristics						
Diode Forward Voltage (Note 3)	V_{SD}	$V_{GS}=0V, I_S=-10A$	-		-1.2	V
Diode Forward Current (Note 2)	I_S		-	-	-20	A
Reverse Recovery Time	t_{rr}	$T_J = 25^{\circ}\text{C}, I_F = -10A$	-	50		nS
Reverse Recovery Charge	Q_{rr}	$di/dt = -100A/\mu s$ (Note3)	-	59		nC
Forward Turn-On Time	t_{on}	Intrinsic turn-on time is negligible (turn-on is dominated by LS+LD)				

Notes:

1. Repetitive Rating: Pulse width limited by maximum junction temperature.
2. Surface Mounted on FR4 Board, $t \leq 10$ sec.
3. Pulse Test: Pulse Width $\leq 300\mu s$, Duty Cycle $\leq 2\%$.
4. Guaranteed by design, not subject to production
5. E_{AS} condition: $T_J=25^{\circ}\text{C}, V_{DD}=-20V, V_G=-10V, L=1mH, R_g=25\Omega, I_{AS}=38A$

Test Circuit

1) E_{AS} Test Circuit

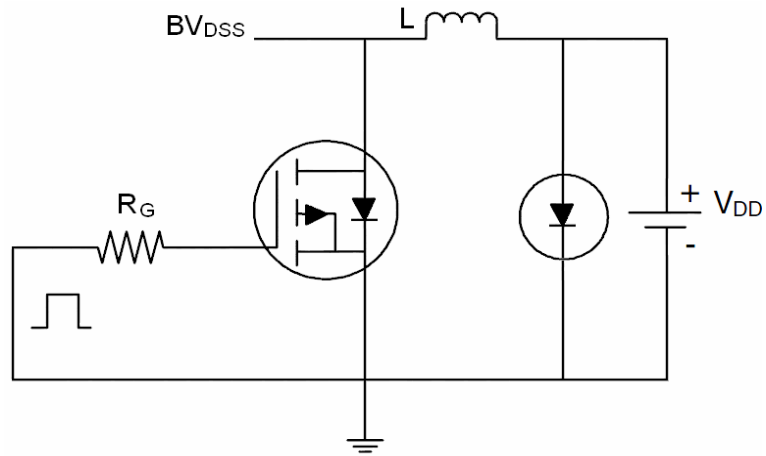

2) Gate Charge Test Circuit

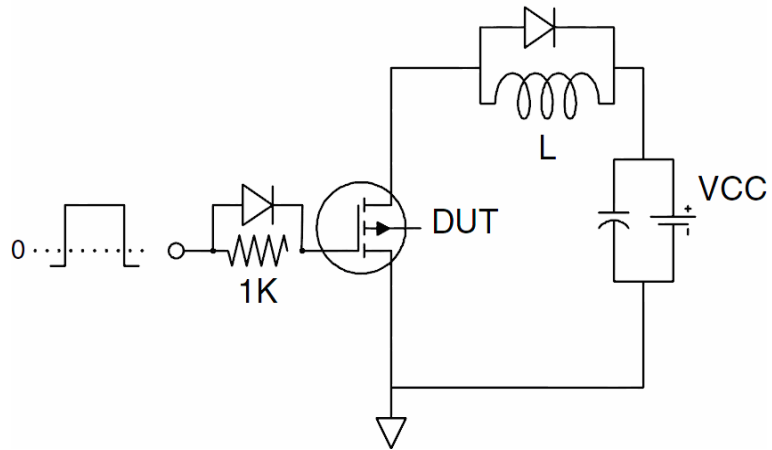

3) Switch Time Test Circuit

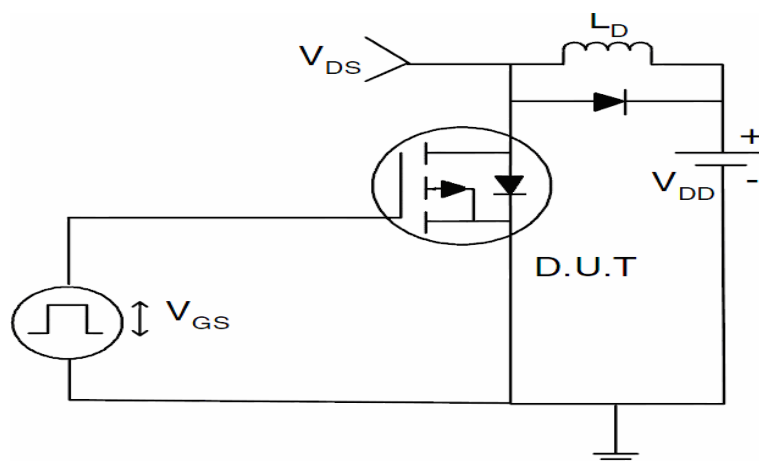

Typical Electrical and Thermal Characteristics (Curves)

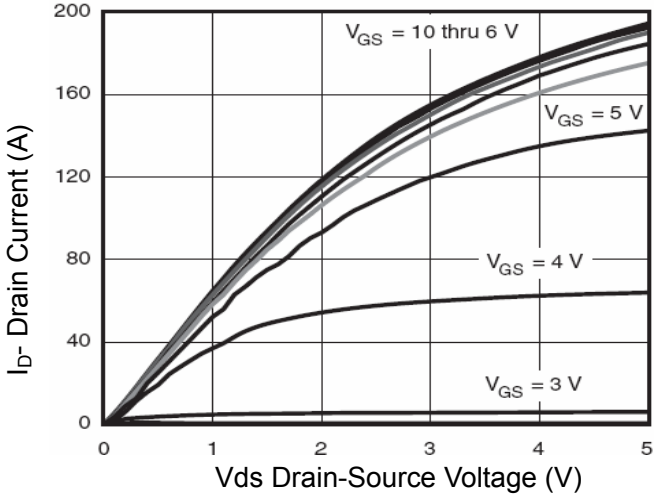

Figure 1 Output Characteristics

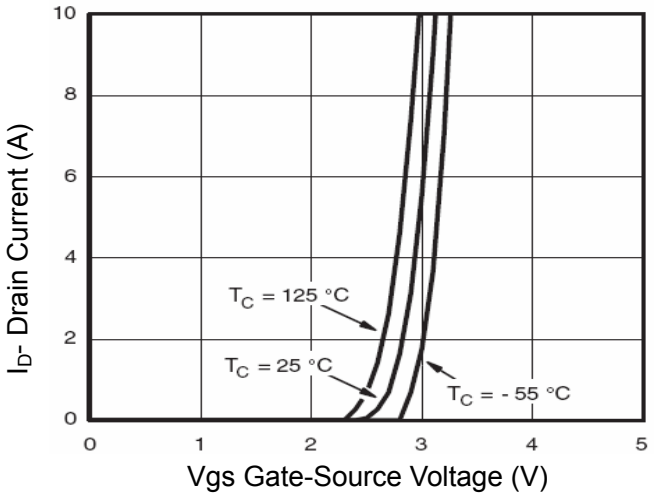

Figure 2 Transfer Characteristics

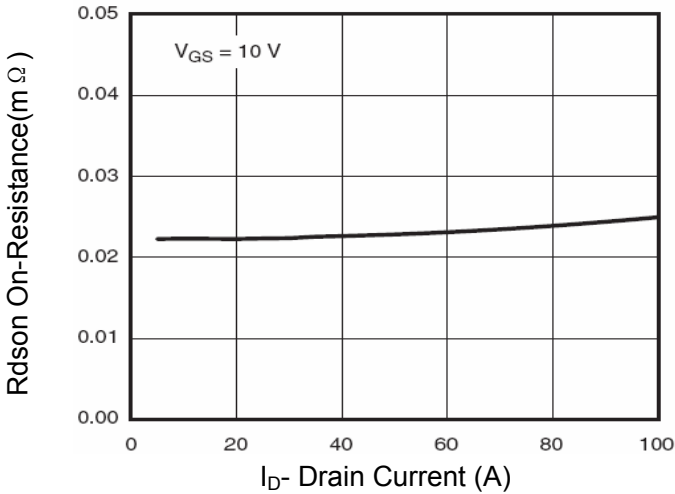

Figure 3 Rdson- Drain Current

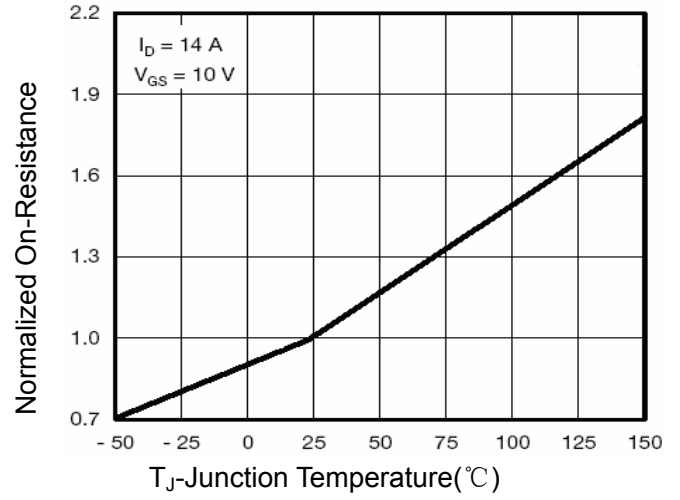

Figure 4 Rdson-Junction Temperature

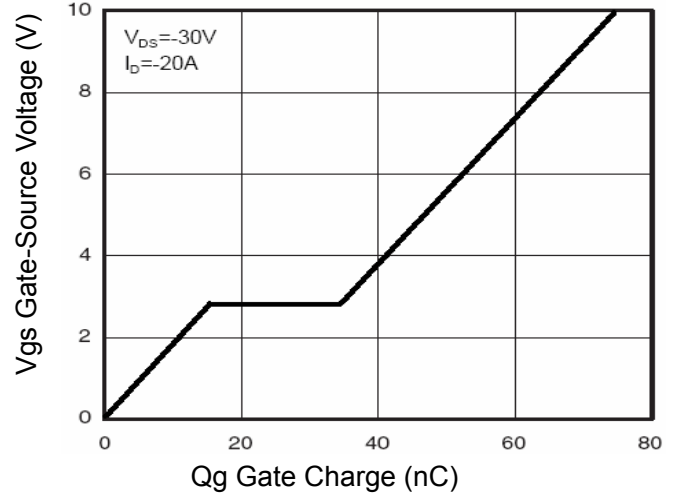

Figure 5 Gate Charge

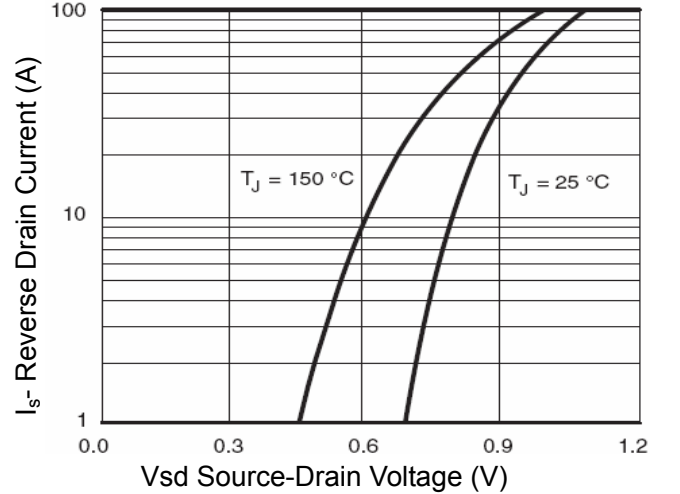

Figure 6 Source- Drain Diode Forward

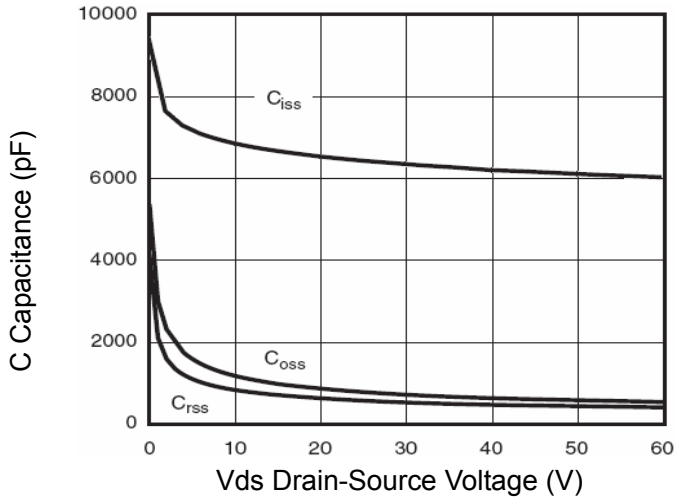

Figure 7 Capacitance vs Vds

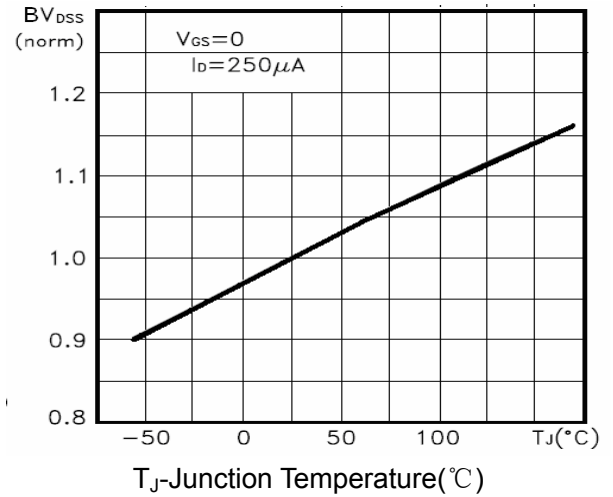

Figure 9 BV_{DSS} vs Junction Temperature

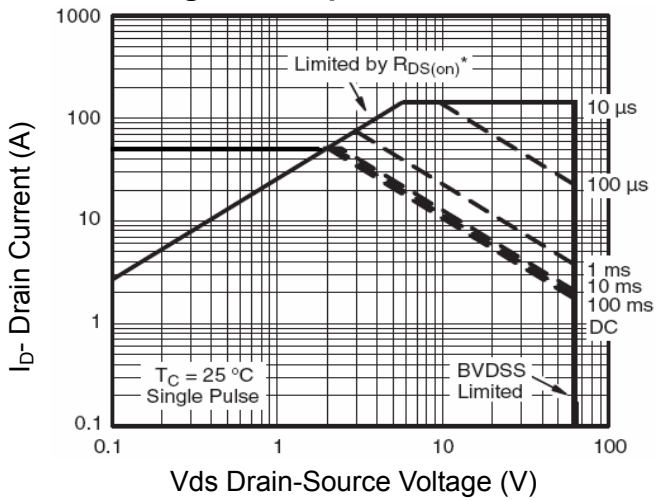

Figure 8 Safe Operation Area

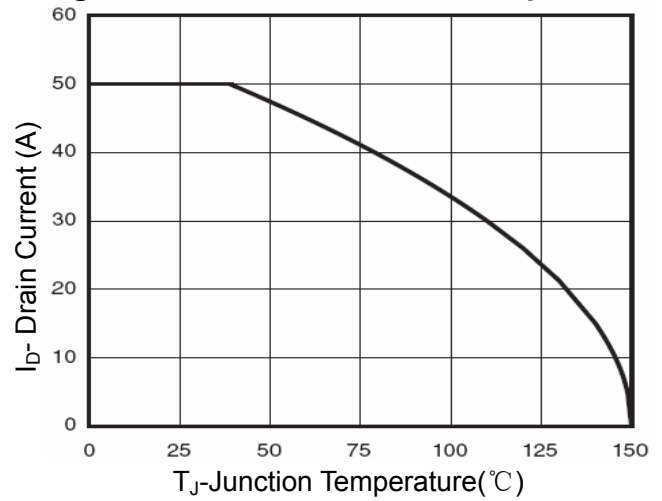

Figure 10 I_D Current Derating vs Junction Temperature

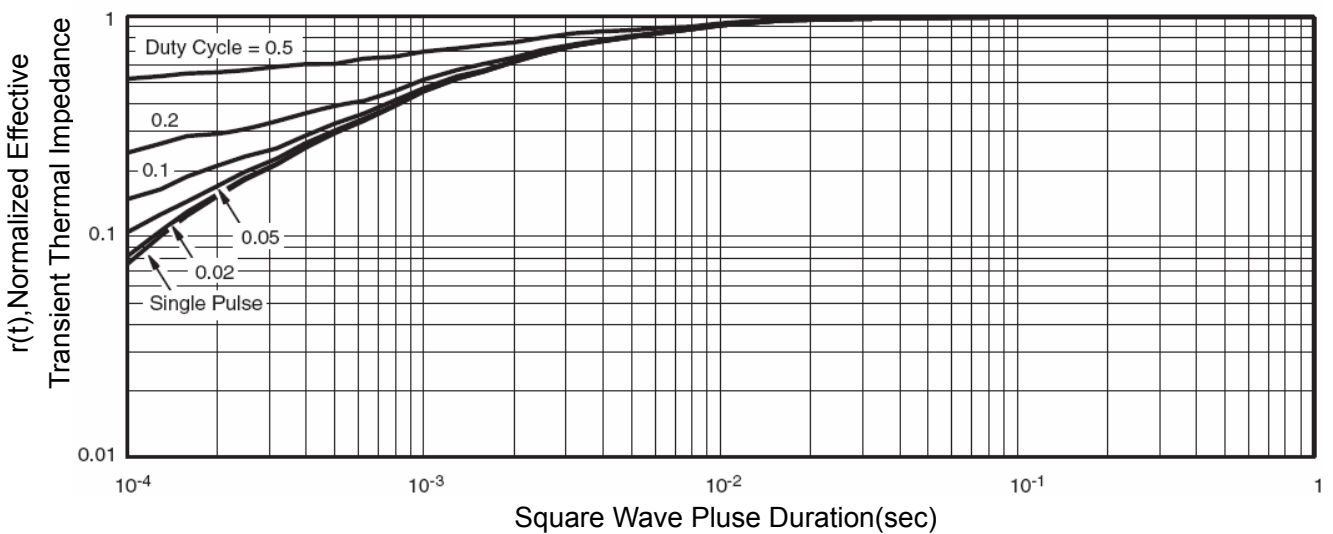
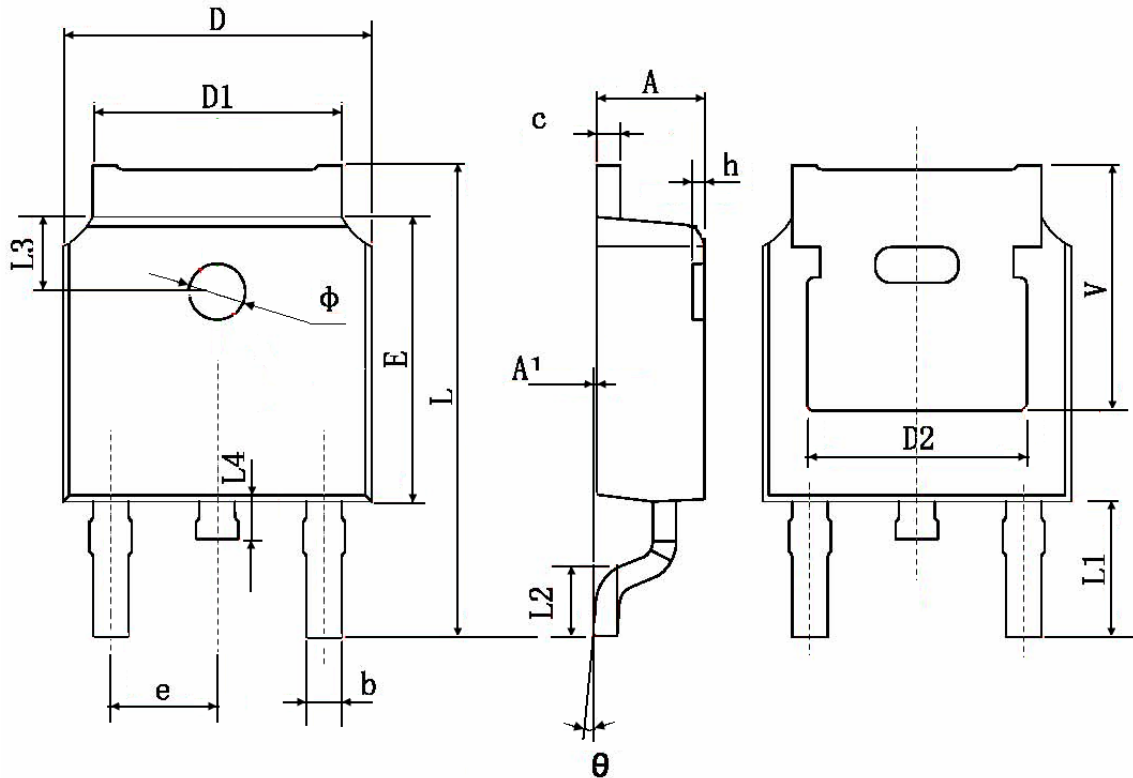

Figure 11 Normalized Maximum Transient Thermal Impedance

TO-252 Package Information



Symbol	Dimensions In Millimeters		Dimensions In Inches	
	Min.	Max.	Min.	Max.
A	2.200	2.400	0.087	0.094
A1	0.000	0.127	0.000	0.005
b	0.660	0.860	0.026	0.034
c	0.460	0.580	0.018	0.023
D	6.500	6.700	0.256	0.264
D1	5.100	5.460	0.201	0.215
D2	0.483 TYP.		0.190 TYP.	
E	6.000	6.200	0.236	0.244
e	2.186	2.386	0.086	0.094
L	9.800	10.400	0.386	0.409
L1	2.900 TYP.		0.114 TYP.	
L2	1.400	1.700	0.055	0.067
L3	1.600 TYP.		0.063 TYP.	
L4	0.600	1.000	0.024	0.039
Φ	1.100	1.300	0.043	0.051
θ	0°	8°	0°	8°
h	0.000	0.300	0.000	0.012
V	5.350 TYP.		0.211 TYP.	