

P-Channel Enhancement Mode Power MOSFET

Description

The HM50P03D uses advanced trench technology and design to provide excellent $R_{DS(ON)}$ with low gate charge. It can be used in a wide variety of applications.

General Features

- $V_{DS} = -30V, I_D = -50A$
 $R_{DS(ON)} < 7m\Omega @ V_{GS} = -10V$

- High density cell design for ultra low R_{dson}
- Fully characterized avalanche voltage and current
- Good stability and uniformity with high E_{AS}
- Excellent package for good heat dissipation
- Special process technology for high ESD capability

Application

- Battery and loading switching

100% UIS TESTED!

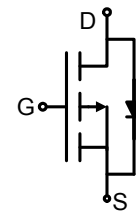

Schematic diagram

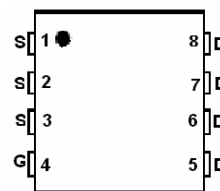

Marking and pin assignment

Package Marking and Ordering Information

Device Marking	Device	Device Package	Reel Size	Tape width	Quantity
HM50P03D	HM50P03D	DFN 5x6 EP	-	-	-

Absolute Maximum Ratings ($T_C=25^\circ C$ unless otherwise noted)

Parameter	Symbol	Limit	Unit
Drain-Source Voltage	V_{DS}	-30	V
Gate-Source Voltage	V_{GS}	± 20	V
Drain Current-Continuous	I_D	-50	A
Pulsed Drain Current	I_{DM}	-150	A
Maximum Power Dissipation	P_D	35	W
Derating factor		0.28	W/ $^\circ C$
Single pulse avalanche energy ^(Note 5)	E_{AS}	300	mJ
Operating Junction and Storage Temperature Range	T_J, T_{STG}	-55 To 150	$^\circ C$

Thermal Characteristic

Thermal Resistance, Junction-to-Case ^(Note 2)	$R_{\theta JC}$	3.6	$^\circ C/W$
--	-----------------	-----	--------------

Electrical Characteristics (TC=25°C unless otherwise noted)

Parameter	Symbol	Condition	Min	Typ	Max	Unit
Off Characteristics						
Drain-Source Breakdown Voltage	BV_{DSS}	$V_{GS}=0V, I_D=-250\mu A$	-30	-33	-	V
Zero Gate Voltage Drain Current	I_{DSS}	$V_{DS}=-30V, V_{GS}=0V$	-	-	1	μA
Gate-Body Leakage Current	I_{GSS}	$V_{GS}=\pm 20V, V_{DS}=0V$	-	-	± 100	nA
On Characteristics (Note 3)						
Gate Threshold Voltage	$V_{GS(th)}$	$V_{DS}=V_{GS}, I_D=-250\mu A$	-1	-1.5	-2.2	V
Drain-Source On-State Resistance	$R_{DS(ON)}$	$V_{GS}=-10V, I_D=-10A$	-	4.4	7	m Ω
Forward Transconductance	g_{FS}	$V_{DS}=-10V, I_D=-15A$	-	20	-	S
Dynamic Characteristics (Note4)						
Input Capacitance	C_{iss}	$V_{DS}=-15V, V_{GS}=0V,$ $F=1.0MHz$	-	3590	-	PF
Output Capacitance	C_{oss}		-	695	-	PF
Reverse Transfer Capacitance	C_{rss}		-	665	-	PF
Switching Characteristics (Note 4)						
Turn-on Delay Time	$t_{d(on)}$	$V_{DD}=-15V, I_D=-10A$ $V_{GS}=-10V, R_{GEN}=6\Omega$	-	13	-	nS
Turn-on Rise Time	t_r		-	12	-	nS
Turn-Off Delay Time	$t_{d(off)}$		-	50	-	nS
Turn-Off Fall Time	t_f		-	14	-	nS
Total Gate Charge	Q_g	$V_{DS}=-15V, I_D=-10A,$ $V_{GS}=-10V$	-	84	-	nC
Gate-Source Charge	Q_{gs}		-	11.7	-	nC
Gate-Drain Charge	Q_{gd}		-	25	-	nC
Drain-Source Diode Characteristics						
Diode Forward Voltage (Note 3)	V_{SD}	$V_{GS}=0V, I_S=-10A$	-	-0.85	-1.2	V
Diode Forward Current (Note 2)	I_S		-	-	-50	A
Reverse Recovery Time	t_{rr}	$T_J = 25^\circ C, I_F = -10A$ $di/dt = 100A/\mu s$ (Note3)	-	-	45	nS
Reverse Recovery Charge	Q_{rr}		-	-	43	nC
Forward Turn-On Time	t_{on}	Intrinsic turn-on time is negligible (turn-on is dominated by LS+LD)				

Notes:

1. Repetitive Rating: Pulse width limited by maximum junction temperature.
2. Surface Mounted on FR4 Board, $t \leq 10$ sec.
3. Pulse Test: Pulse Width $\leq 300\mu s$, Duty Cycle $\leq 2\%$.
4. Guaranteed by design, not subject to production
5. EAS condition: $T_J=25^\circ C, V_{DD}=-15V, V_G=-10V, L=0.5mH, R_g=25\Omega$

Test Circuit

1) E_{AS} Test Circuits

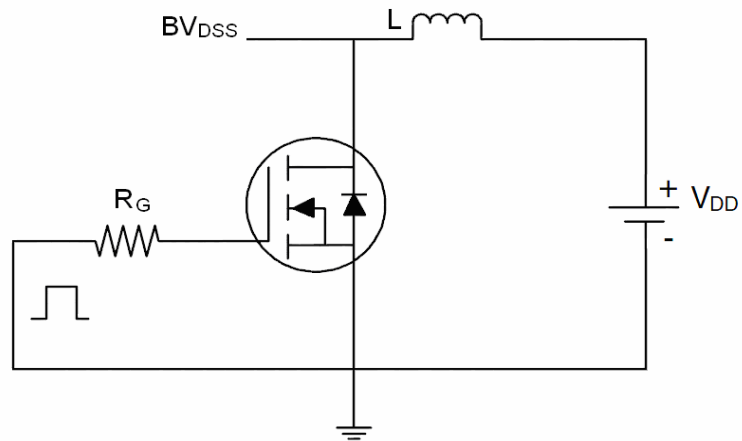

2) Gate Charge Test Circuit

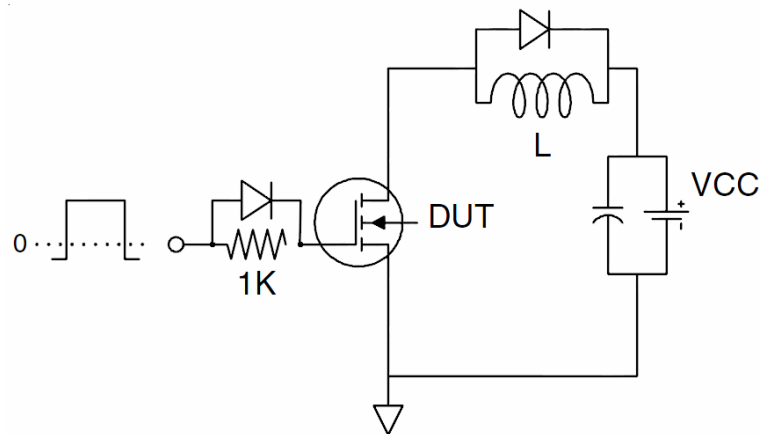

3) Switch Time Test Circuit

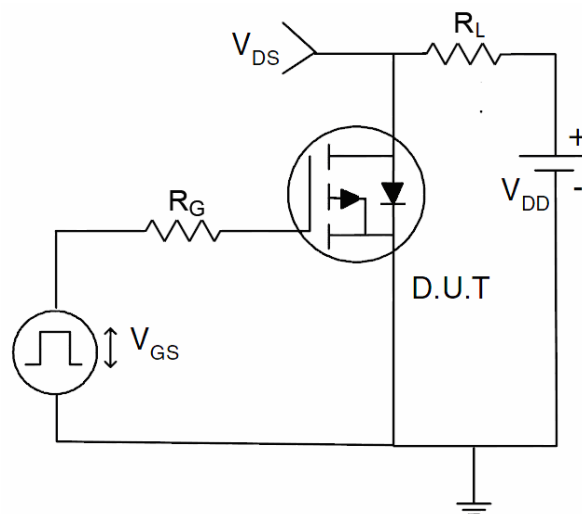

Typical Electrical and Thermal Characteristics (Curves)

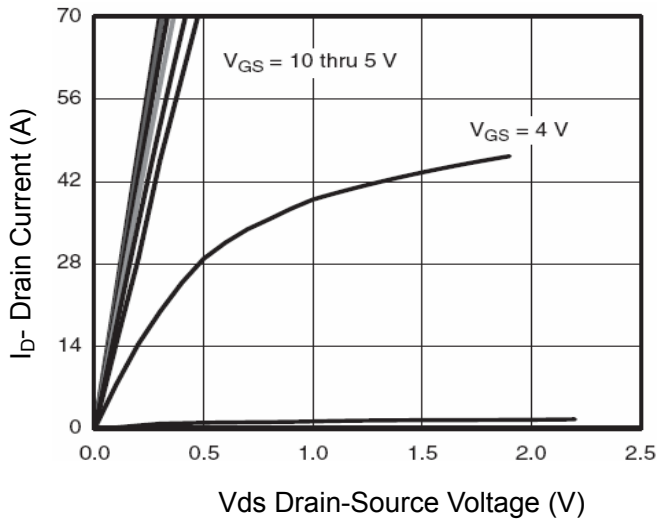

Figure 1 Output Characteristics

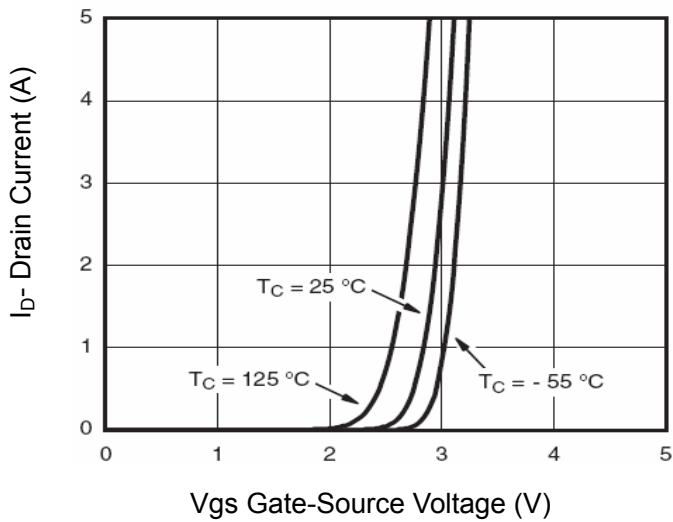

Figure 2 Transfer Characteristics

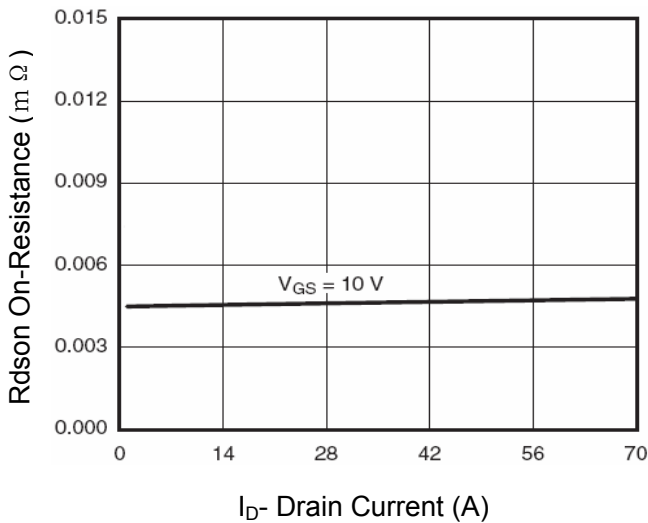

Figure 3 Rdson- Drain Current

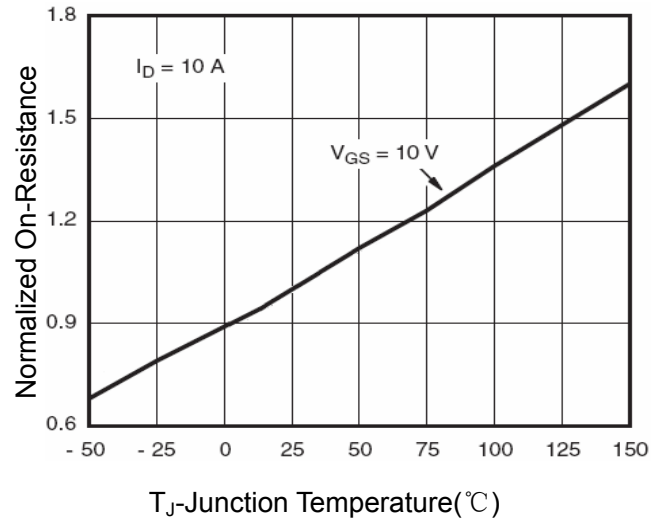

Figure 4 Rdson-Junction Temperature

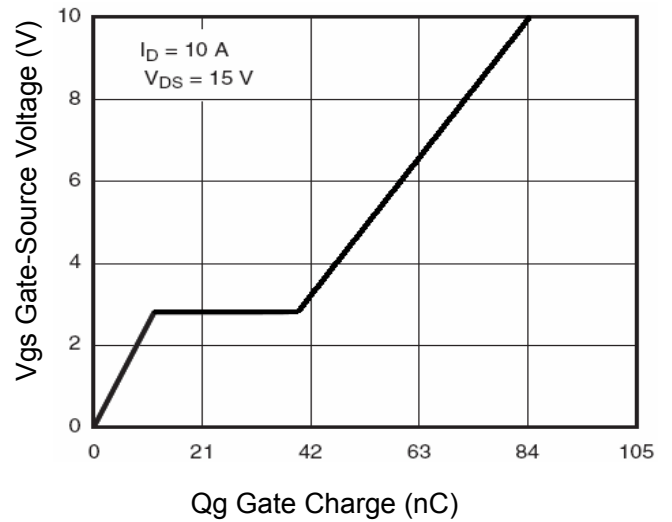

Figure 5 Gate Charge

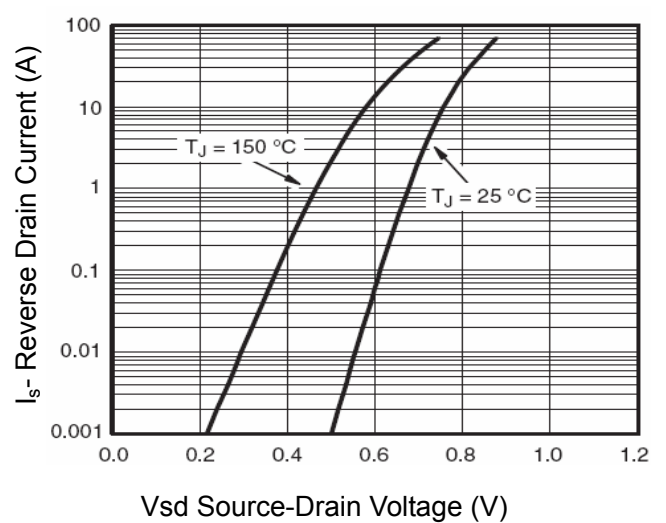

Figure 6 Source- Drain Diode Forward

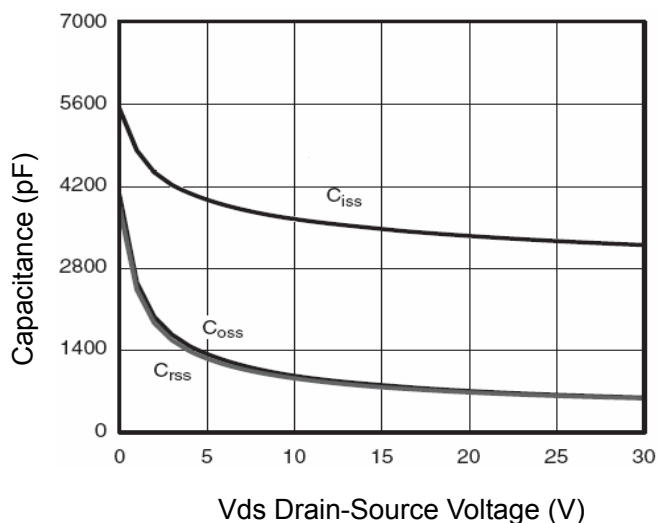

Figure 7 Capacitance vs Vds

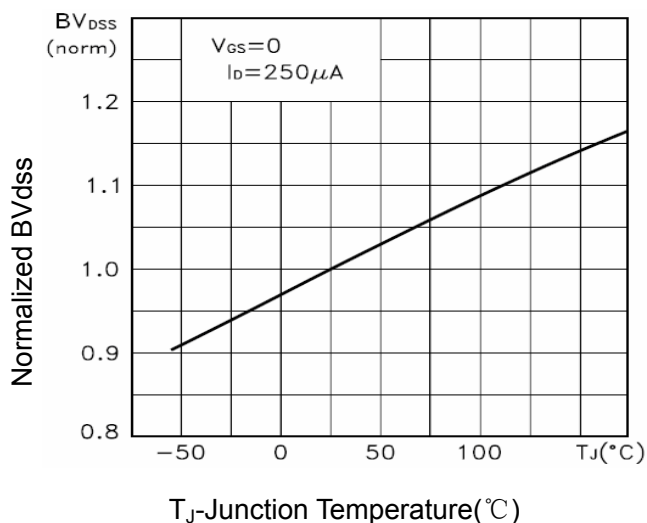

Figure 9 BV_{DSS} vs Junction Temperature

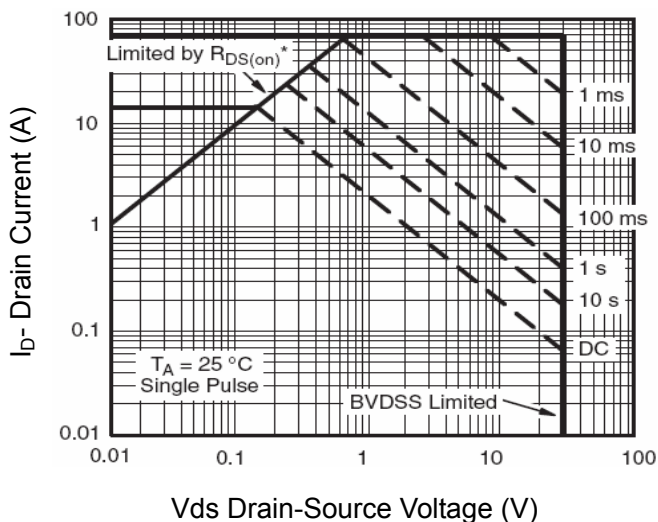

Figure 8 Safe Operation Area

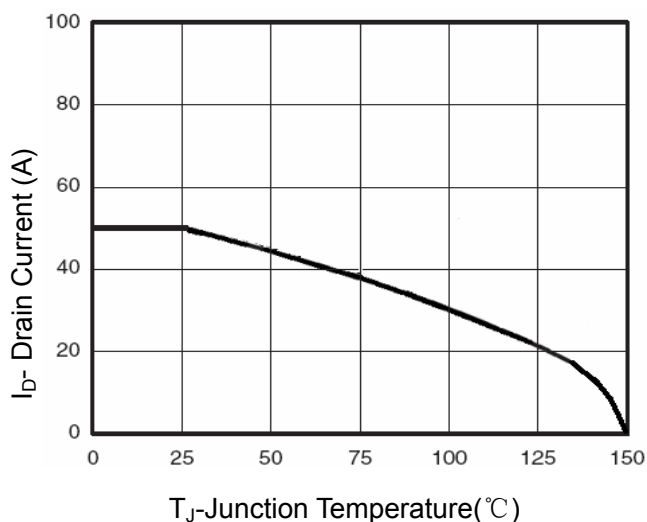

Figure 10 I_D Current Derating vs Junction Temperature

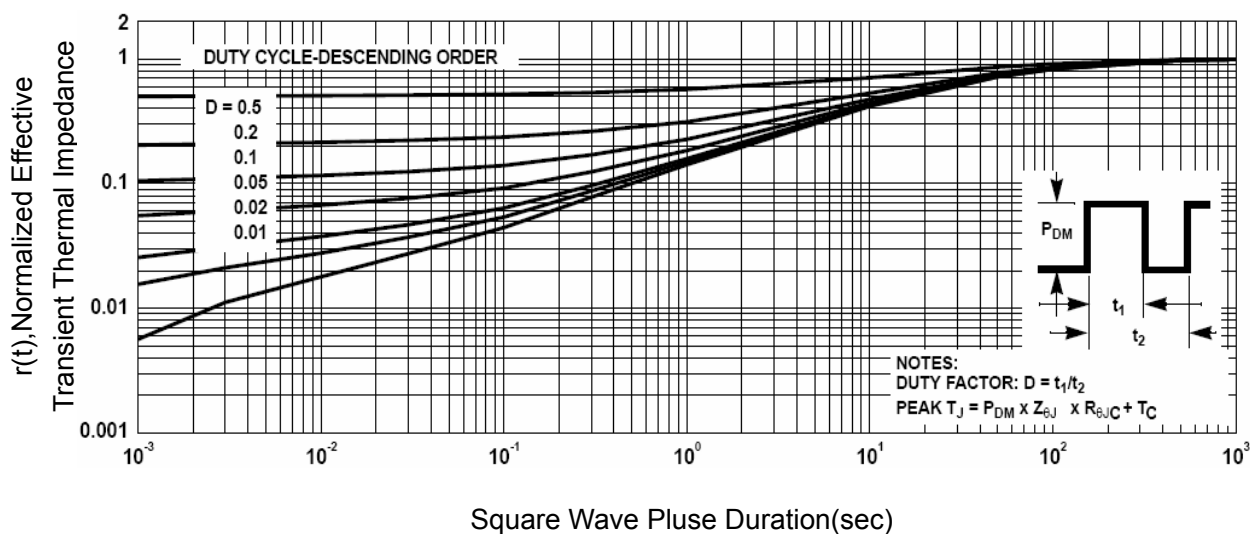
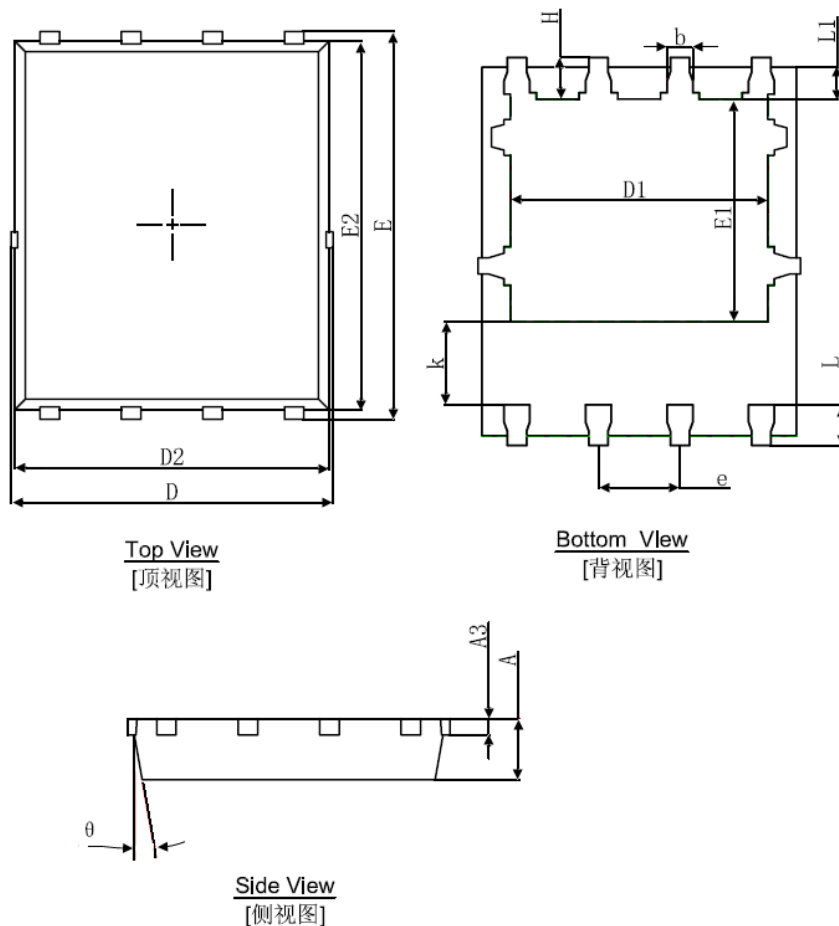

Figure 11 Normalized Maximum Transient Thermal Impedance

DFN5X6-8L Package Information



Symbol	Dimensions In Millimeters		Dimensions In Inches	
	Min.	Max.	Min.	Max.
A	0.900	1.000	0.035	0.039
A3	0.254REF.		0.010REF.	
D	4.944	5.096	0.195	0.201
E	5.974	6.126	0.235	0.241
D1	3.910	4.110	0.154	0.162
E1	3.375	3.575	0.133	0.141
D2	4.824	4.976	0.190	0.196
E2	5.674	5.826	0.223	0.229
K	1.190	1.390	0.047	0.055
b	0.035	0.450	0.014	0.018
e	1.270(TYP.)		0.050(TYP.)	
L	0.559	0.711	0.022	0.028
L1	0.424	0.576	0.017	0.023
H	0.574	0.726	0.023	0.029
θ	8°	12°	8°	12°