

## P-Channel Enhancement Mode Power MOSFET

### DESCRIPTION

The HM4P15Q uses advanced trench technology to provide excellent  $R_{DS(ON)}$ , low gate charge and operation with gate voltages as low as 4.5V.

### GENERAL FEATURES

- $V_{DS} = -150V, I_D = -4A$   
 $R_{DS(ON)} < 980m\Omega @ V_{GS} = -6V$   
 $R_{DS(ON)} < 780m\Omega @ V_{GS} = -10V$
- High Power and current handing capability
- Lead free product is acquired
- Surface Mount Package

### Application

- Battery Switch
- Load switch
- Power management

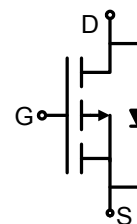

Schematic diagram

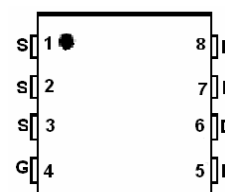

Marking and pin assignment

### Package Marking And Ordering Information

Device Marking	Device	Device Package	Reel Size	Tape width	Quantity
HM4P15Q	HM4P15Q	DFN3X3-8L	Ø330mm	12mm	2500 units

### Absolute Maximum Ratings (TA=25°C unless otherwise noted)

Parameter	Symbol	Limit	Unit
Drain-Source Voltage	$V_{DS}$	-150	V
Gate-Source Voltage	$V_{GS}$	±20	V
Drain Current-Continuous	$I_D$	-4	A
Drain Current-Pulsed (Note 1)	$I_{DM}$	-12	A
Maximum Power Dissipation	$P_D$	50	W
Operating Junction and Storage Temperature Range	$T_J, T_{STG}$	-55 To 150	°C

### Thermal Characteristic

Thermal Resistance, Junction-to-Ambient (Note 2)	$R_{\theta JA}$	40	°C/W
--	-----------------	----	------

### Electrical Characteristics (TA=25°C unless otherwise noted)

Parameter	Symbol	Condition	Min	Typ	Max	Unit
<b>Off Characteristics</b>						
Drain-Source Breakdown Voltage	$BV_{DSS}$	$V_{GS} = 0V, I_D = -250\mu A$	-30	-33	-	V

Zero Gate Voltage Drain Current	$I_{DSS}$	$V_{DS}=-150V, V_{GS}=0V$	-	-	-1	$\mu A$
Gate-Body Leakage Current	$I_{GSS}$	$V_{GS}=\pm 20V, V_{DS}=0V$	-	-	$\pm 100$	nA
<b>On Characteristics (Note 3)</b>						
Gate Threshold Voltage	$V_{GS(th)}$	$V_{DS}=V_{GS}, I_D=-250\mu A$	-2	-	-4	V
Drain-Source On-State Resistance	$R_{DS(ON)}$	$V_{GS}=-10V, I_D=-1A$	-	-	780	m $\Omega$
		$V_{GS}=-6.0V, I_D=-0.5A$	-	-	980	m $\Omega$
Forward Transconductance	$g_{FS}$	$V_{DS}=-15V, I_D=-9.1A$	10	-	-	S
<b>Dynamic Characteristics (Note4)</b>						
Input Capacitance	$C_{iss}$	$V_{DS}=-15V, V_{GS}=0V,$ $F=1.0MHz$	-	1600	-	PF
Output Capacitance	$C_{oss}$		-	350	-	PF
Reverse Transfer Capacitance	$C_{rss}$		-	300	-	PF
<b>Switching Characteristics (Note 4)</b>						
Turn-on Delay Time	$t_{d(on)}$	$V_{DD}=-15V, I_D=-1A,$ $V_{GS}=-10V, R_{GEN}=6\Omega$	-	10	-	nS
Turn-on Rise Time	$t_r$		-	15	-	nS
Turn-Off Delay Time	$t_{d(off)}$		-	110	-	nS
Turn-Off Fall Time	$t_f$		-	70	-	nS
Total Gate Charge	$Q_g$	$V_{DS}=-15V, I_D=-9.1A$ $V_{GS}=-10V$	-	30	-	nC
Gate-Source Charge	$Q_{gs}$		-	5.5	-	nC
Gate-Drain Charge	$Q_{gd}$		-	8	-	nC
<b>Drain-Source Diode Characteristics</b>						
Diode Forward Voltage (Note 3)	$V_{SD}$	$V_{GS}=0V, I_S=-2.1A$	-	-	-1.2	V

**Notes:**

1. Repetitive Rating: Pulse width limited by maximum junction temperature.
2. Surface Mounted on FR4 Board,  $t \leq 10$  sec.
3. Pulse Test: Pulse Width  $\leq 300\mu s$ , Duty Cycle  $\leq 2\%$ .
4. Guaranteed by design, not subject to production

TYPICAL ELECTRICAL AND THERMAL CHARACTERISTICS



Figure 1: Switching Test Circuit

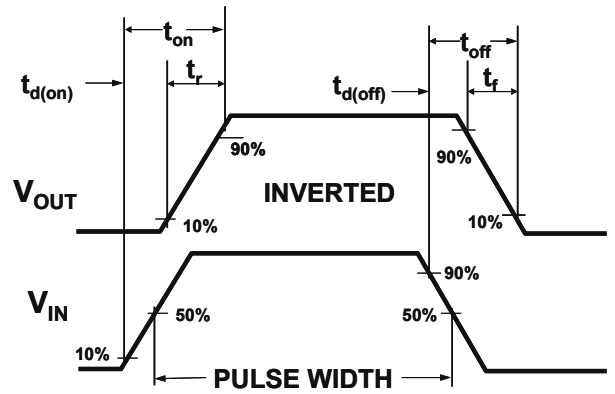

Figure 2: Switching Waveforms

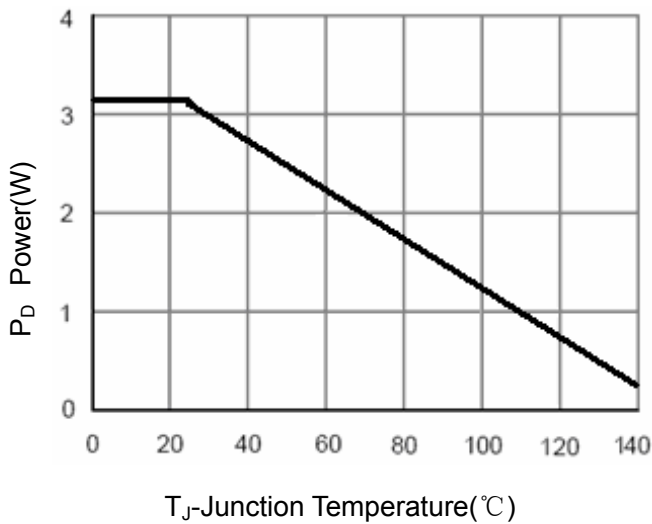

Figure 3 Power Dissipation

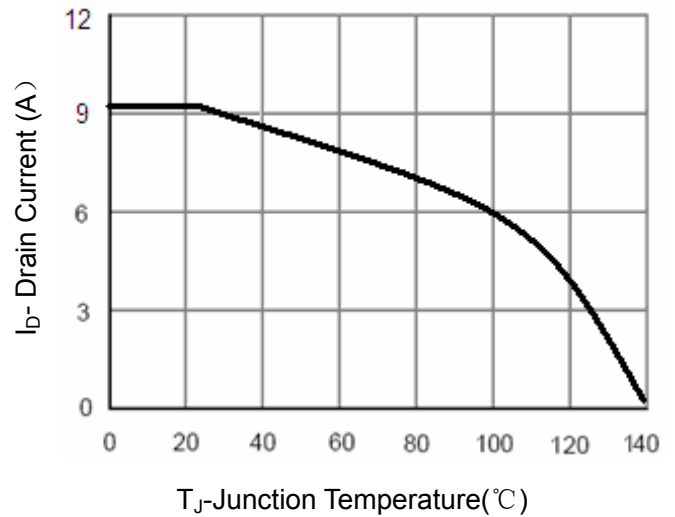

Figure 4 Drain Current

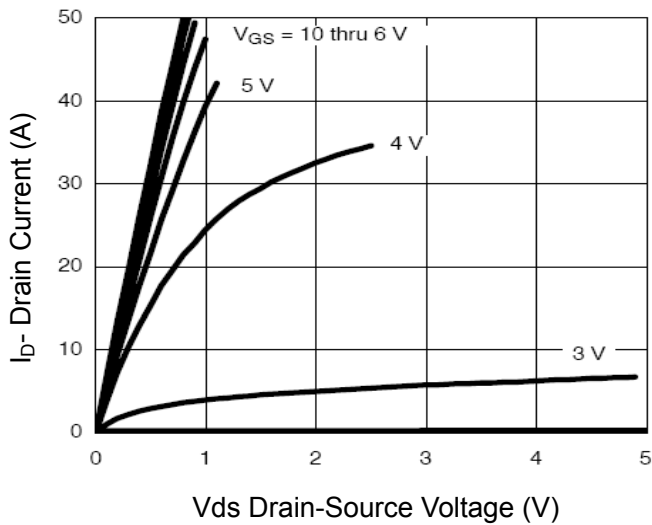

Figure 5 Output CHARACTERISTICS

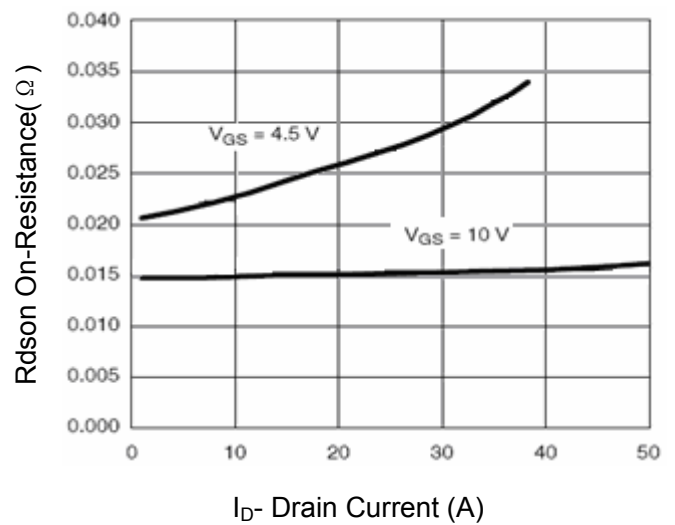

Figure 6 Drain-Source On-Resistance

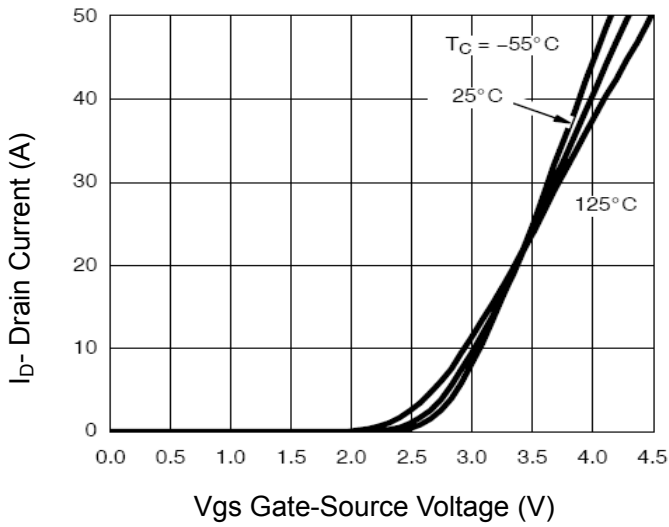

Figure 7 Transfer Characteristics

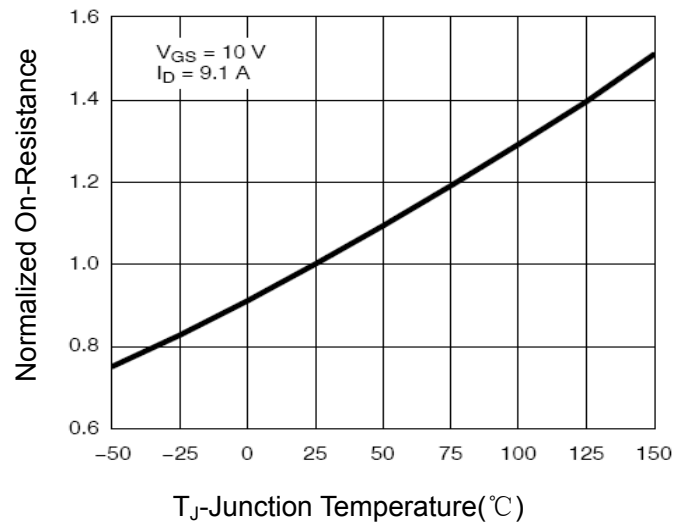

Figure 8 Drain-Source On-Resistance

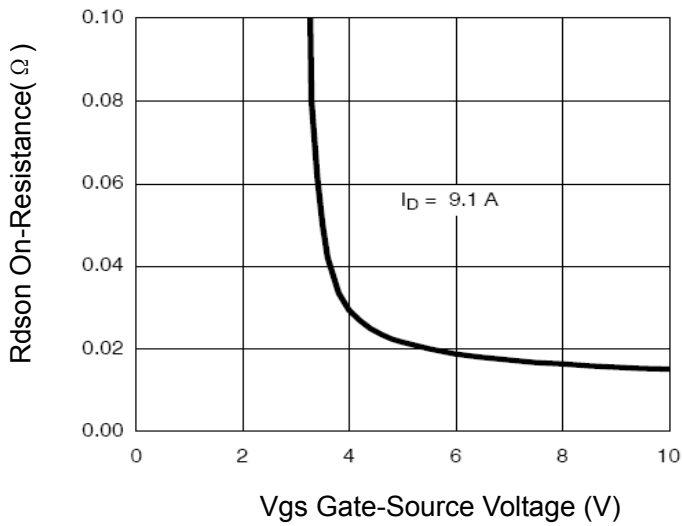

Figure 9  $R_{DS(on)}$  vs  $V_{GS}$

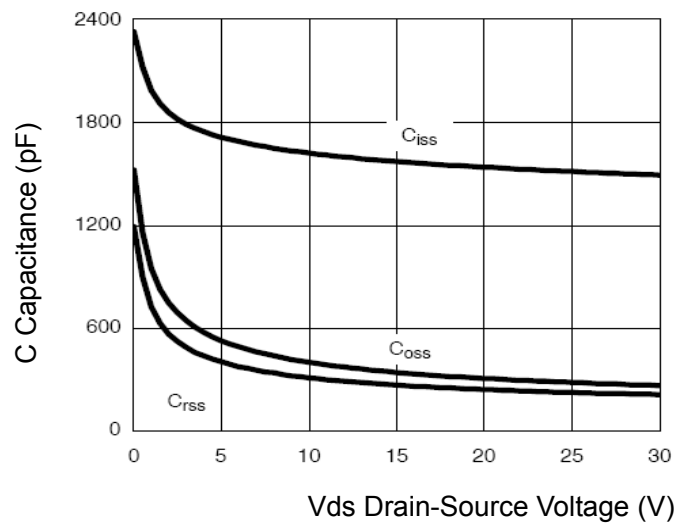

Figure 10 Capacitance vs  $V_{DS}$

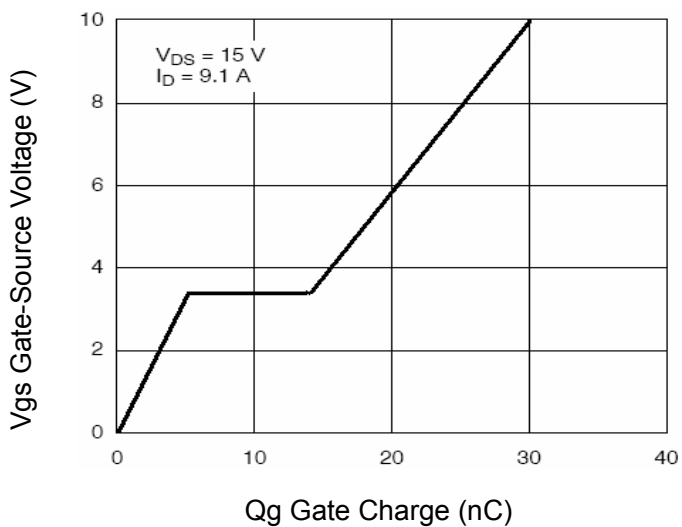

Figure 11 Gate Charge

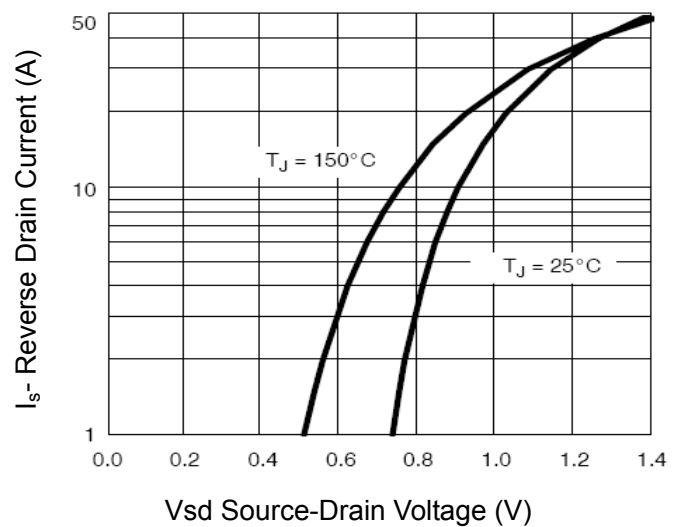

Figure 12 Source- Drain Diode Forward

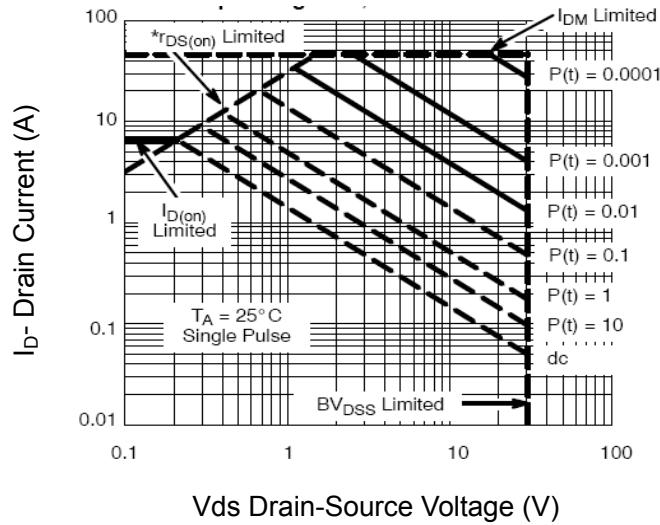

Figure 13 Safe Operation Area

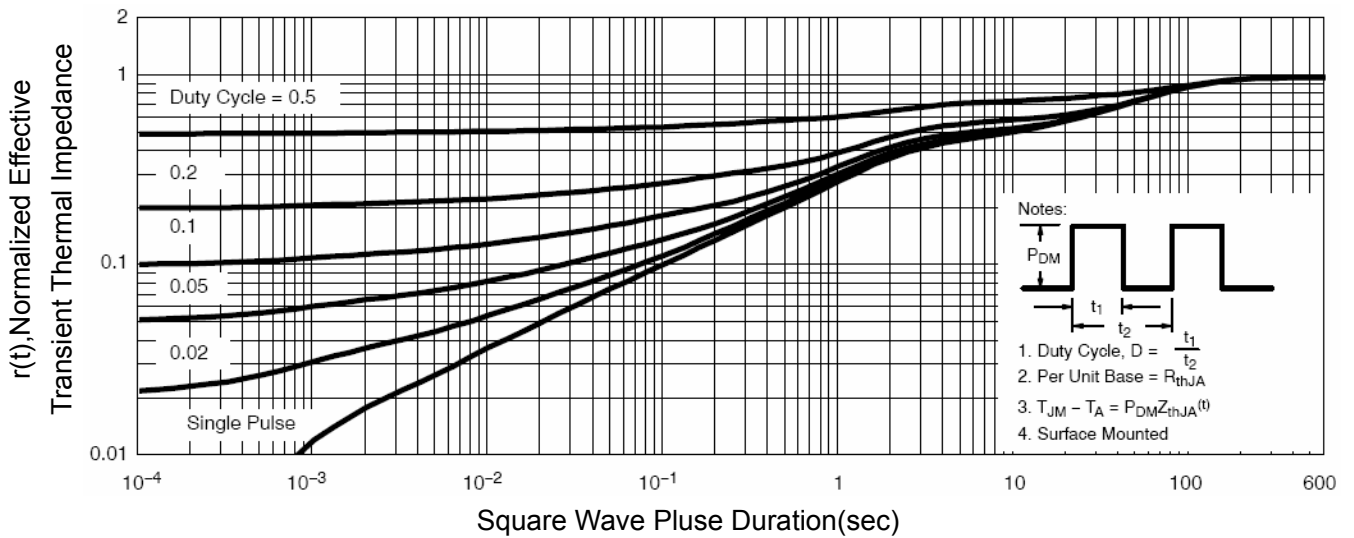
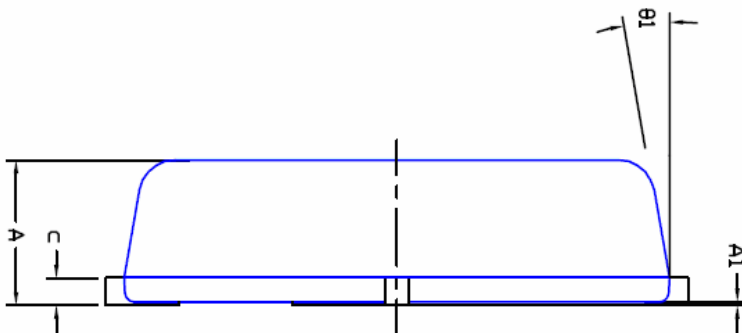
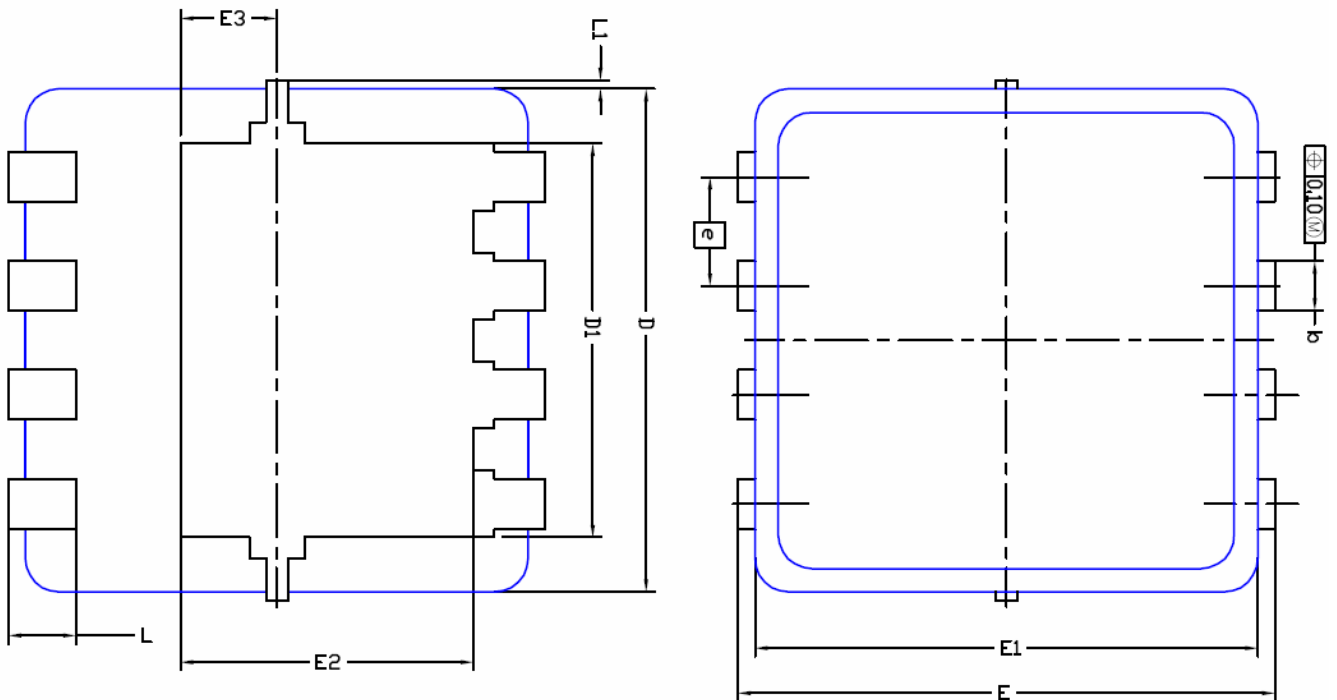

Figure 14 Normalized Maximum Transient Thermal Impedance

DFN3X3 EP Package Information



DIM.	MILLIMETERS			INCHES		
	MIN	NOM	MAX	MIN	NOM	MAX
A	0,700	0,80	0,900	0,0276	0,0315	0,0354
A1	0,00	---	0,05	0,000	---	0,002
b	0,24	0,30	0,35	0,009	0,012	0,014
c	0,10	0,152	0,25	0,004	0,006	0,010
D	3,00 BSC			0,118 BSC		
D1	2,35 BSC			0,093 BSC		
E	3,20 BSC			0,126 BSC		
E1	3,00 BSC			0,118 BSC		
E2	1,75 BSC			0,069 BSC		
E3	0,575 BSC			0,023 BSC		
e	0,65 BSC			0,026 BSC		
L	0,30	0,40	0,50	0,0118	0,0157	0,0197
L1	0	---	0,100	0	---	0,004
θ1	0°	10°	12°	0°	10°	12°