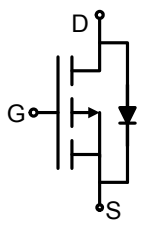
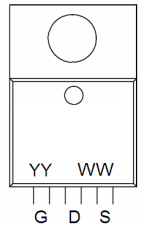
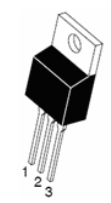

P-Channel Enhancement Mode Power MOSFET

<p><b>DESCRIPTION</b></p> <p>The HM35P03K uses advanced trench technology to provide excellent <math>R_{DS(ON)}</math>, low gate charge and operation with gate voltages as low as 4.5V.</p> <p><b>GENERAL FEATURES</b></p> <ul style="list-style-type: none"> <li>● <math>V_{DS} = -30V, I_D = -35A</math></li> <li>● <math>R_{DS(ON)} &lt; 25m\Omega @ V_{GS}=-4.5V</math></li> <li>● <math>R_{DS(ON)} &lt; 16m\Omega @ V_{GS}=-10V</math></li> <li>● High Power and current handing capability</li> <li>● Lead free product is acquired</li> <li>● Surface Mount Package</li> </ul> <p><b>Application</b></p> <ul style="list-style-type: none"> <li>● Battery Switch</li> <li>● Load switch</li> <li>● Power management</li> </ul>	 <p style="text-align: center;">Schematic diagram</p>  <p style="text-align: center;">Marking and pin Assignment</p>  <p style="text-align: center;">TO-220 top view</p>
--	--

**Package Marking And Ordering Information**

Device Marking	Device	Device Package	Reel Size	Tape width	Quantity
HM35P03	HM35P03	TO-220-3L	Ø330mm	12mm	2500 units

**Absolute Maximum Ratings (TA=25°C unless otherwise noted)**

Parameter	Symbol	Limit	Unit
Drain-Source Voltage	$V_{DS}$	-30	V
Gate-Source Voltage	$V_{GS}$	±20	V
Drain Current-Continuous	$I_D$	-35	A
Drain Current-Pulsed (Note 1)	$I_{DM}$	-105	A
Maximum Power Dissipation	$P_D$	65	W
Operating Junction and Storage Temperature Range	$T_J, T_{STG}$	-55 To 150	°C

**Thermal Characteristic**

Thermal Resistance, Junction-to-Ambient (Note 2)	$R_{\theta JA}$	40	°C/W
--	-----------------	----	------

**Electrical Characteristics (TA=25°C unless otherwise noted)**

Parameter	Symbol	Condition	Min	Typ	Max	Unit
<b>Off Characteristics</b>						
Drain-Source Breakdown Voltage	$BV_{DSS}$	$V_{GS}=0V, I_D=-250\mu A$	-30	-33	-	V

Zero Gate Voltage Drain Current	$I_{DSS}$	$V_{DS}=-30V, V_{GS}=0V$	-	-	-1	$\mu A$
Gate-Body Leakage Current	$I_{GSS}$	$V_{GS}=\pm 20V, V_{DS}=0V$	-	-	$\pm 100$	nA
<b>On Characteristics (Note 3)</b>						
Gate Threshold Voltage	$V_{GS(th)}$	$V_{DS}=V_{GS}, I_D=-250\mu A$	-1	-1.5	-3	V
Drain-Source On-State Resistance	$R_{DS(on)}$	$V_{GS}=-10V, I_D=-20A$	-	11.5	15	m $\Omega$
		$V_{GS}=-4.5V, I_D=-10A$	-	18	25	m $\Omega$
Forward Transconductance	$g_{FS}$	$V_{DS}=-15V, I_D=-10A$	10	-	-	S
<b>Dynamic Characteristics (Note4)</b>						
Input Capacitance	$C_{iss}$	$V_{DS}=-15V, V_{GS}=0V,$ $F=1.0MHz$	-	1600	-	PF
Output Capacitance	$C_{oss}$		-	350	-	PF
Reverse Transfer Capacitance	$C_{rss}$		-	300	-	PF
<b>Switching Characteristics (Note 4)</b>						
Turn-on Delay Time	$t_{d(on)}$	$V_{DD}=-15V, I_D=-1A,$ $V_{GS}=-10V, R_{GEN}=6\Omega$	-	10	-	nS
Turn-on Rise Time	$t_r$		-	15	-	nS
Turn-Off Delay Time	$t_{d(off)}$		-	110	-	nS
Turn-Off Fall Time	$t_f$		-	70	-	nS
Total Gate Charge	$Q_g$	$V_{DS}=-15V, I_D=-20A$ $V_{GS}=-10V$	-	30	-	nC
Gate-Source Charge	$Q_{gs}$		-	5.5	-	nC
Gate-Drain Charge	$Q_{gd}$		-	8	-	nC
<b>Drain-Source Diode Characteristics</b>						
Diode Forward Voltage (Note 3)	$V_{SD}$	$V_{GS}=0V, I_S=-2.1A$	-	-	-1.2	V

**Notes:**

1. Repetitive Rating: Pulse width limited by maximum junction temperature.
2. Surface Mounted on FR4 Board,  $t \leq 10$  sec.
3. Pulse Test: Pulse Width  $\leq 300\mu s$ , Duty Cycle  $\leq 2\%$ .
4. Guaranteed by design, not subject to production

TYPICAL ELECTRICAL AND THERMAL CHARACTERISTICS



Figure 1: Switching Test Circuit

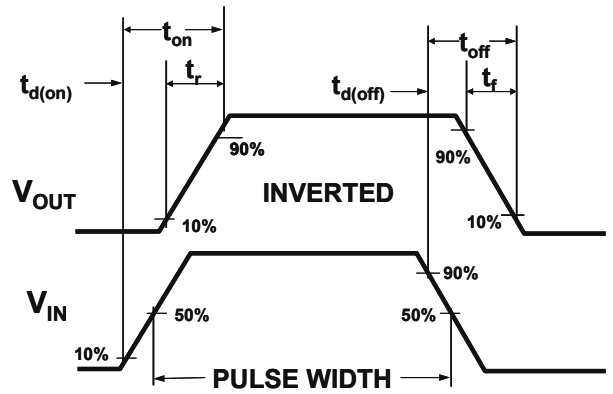

Figure 2: Switching Waveforms

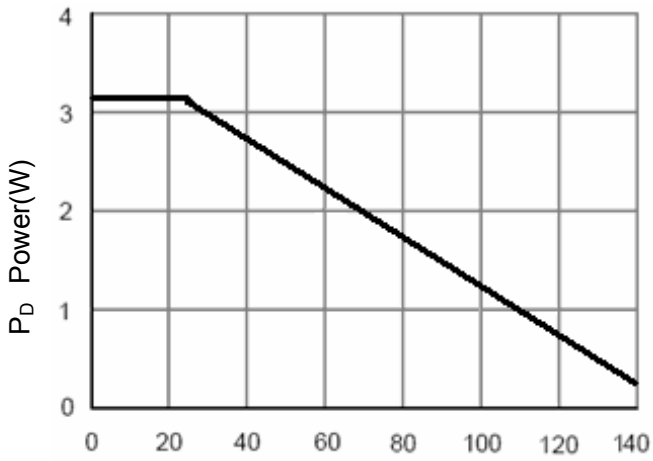

Figure 3 Power Dissipation

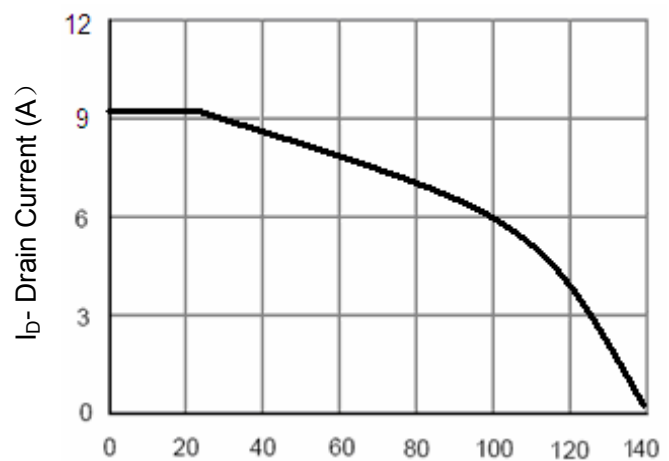

Figure 4 Drain Current

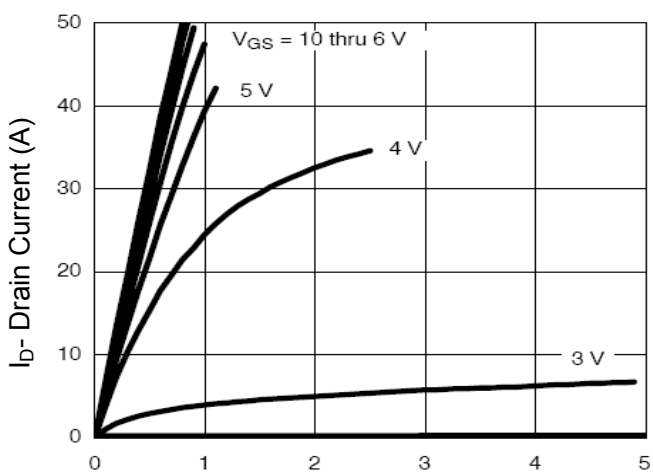

Figure 5 Output CHARACTERISTICS

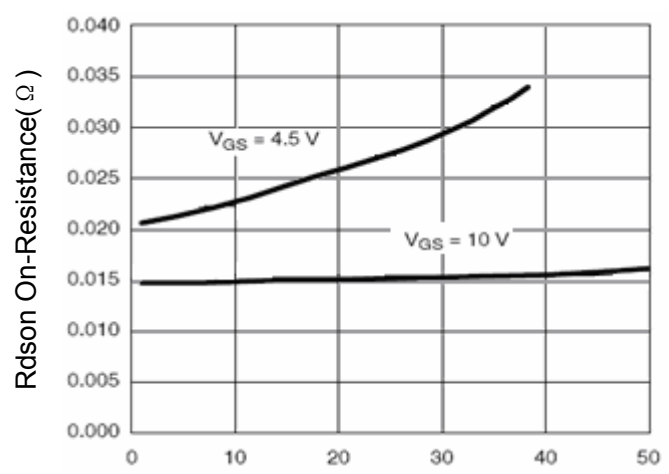

Figure 6 Drain-Source On-Resistance

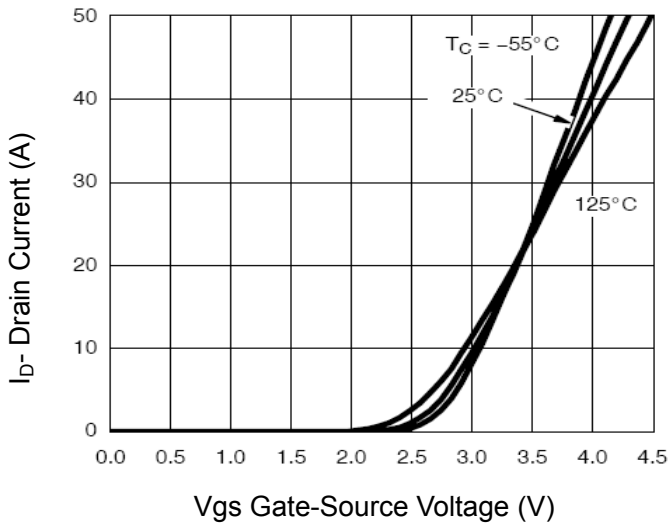

Figure 7 Transfer Characteristics

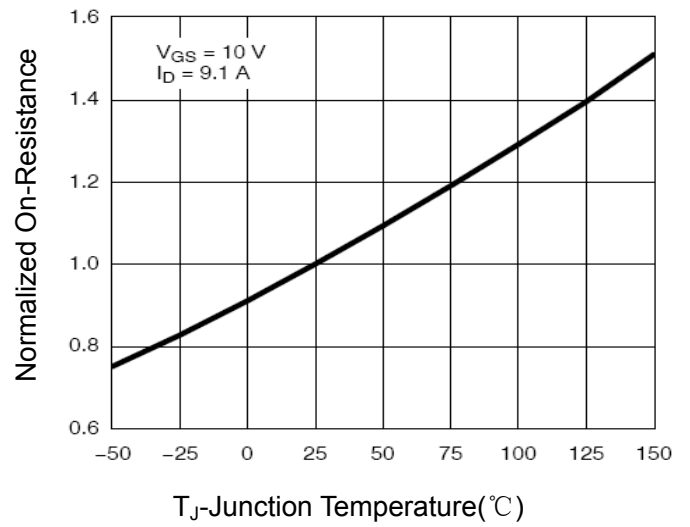

Figure 8 Drain-Source On-Resistance

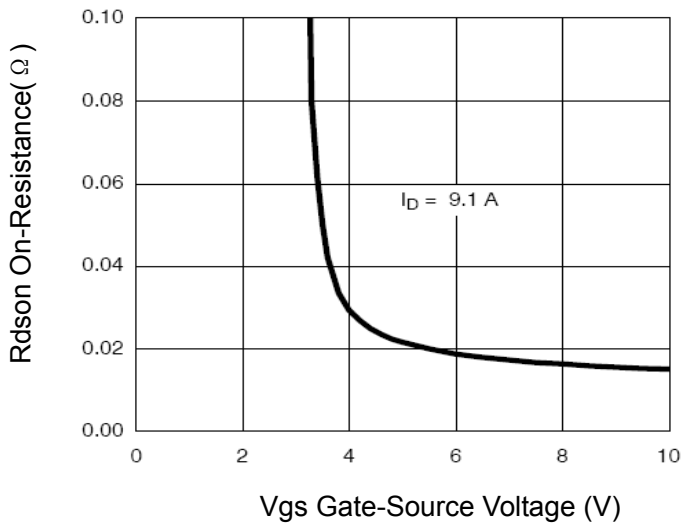

Figure 9 Rdson vs Vgs

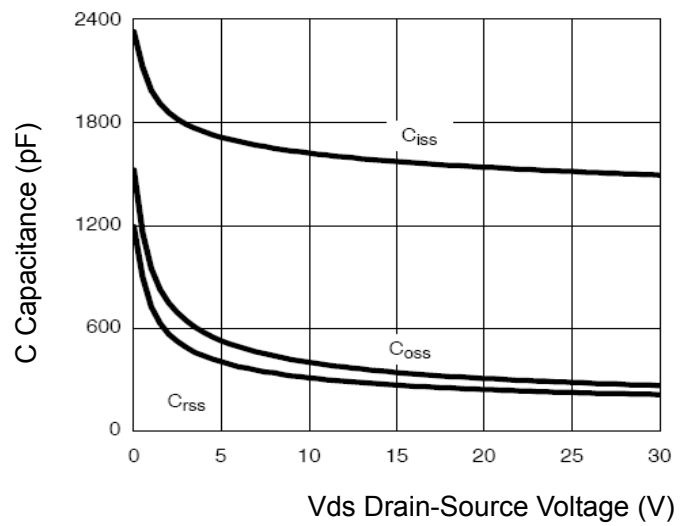

Figure 10 Capacitance vs Vds

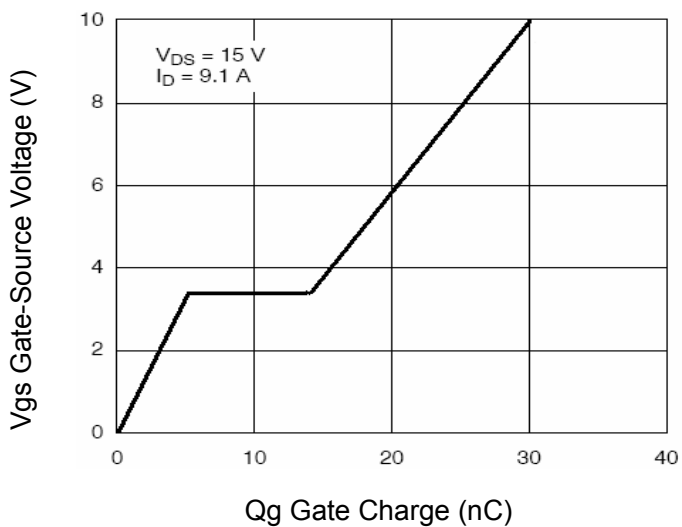

Figure 11 Gate Charge

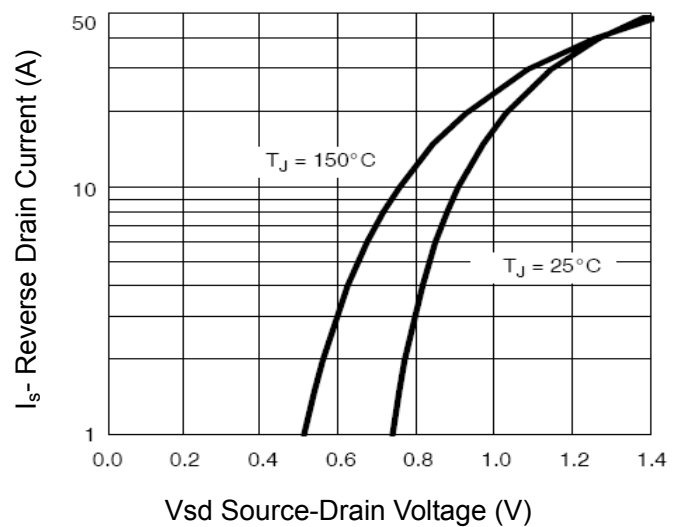

Figure 12 Source- Drain Diode Forward

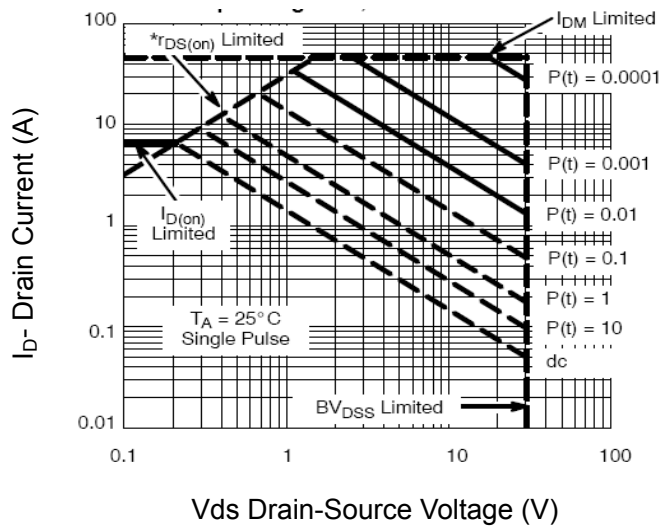

Figure 13 Safe Operation Area

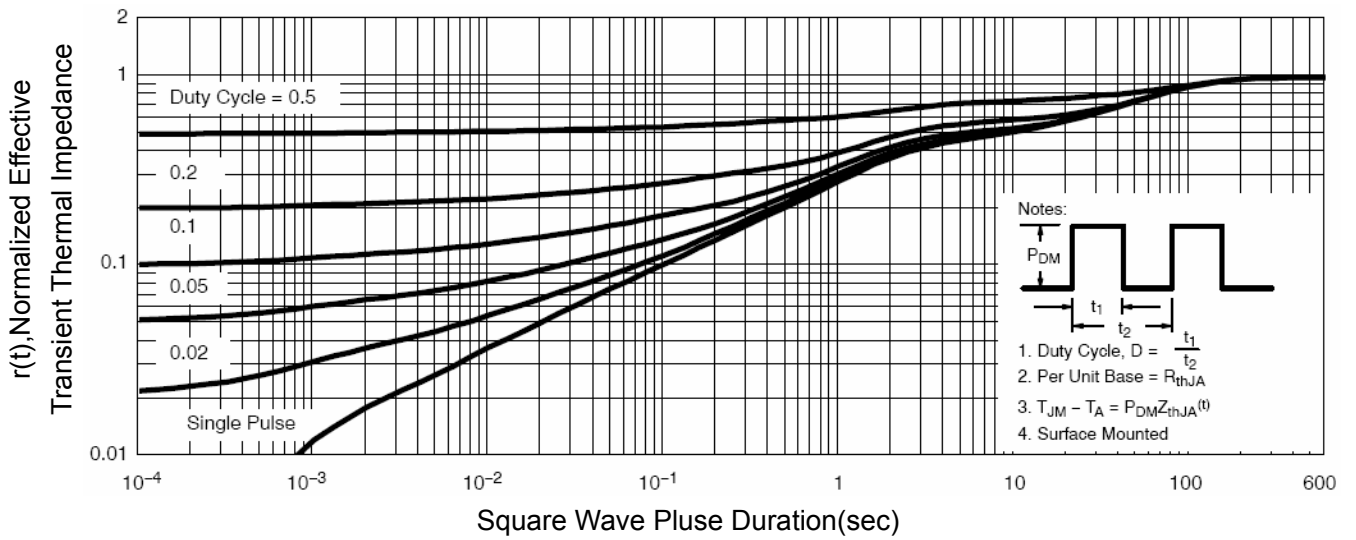
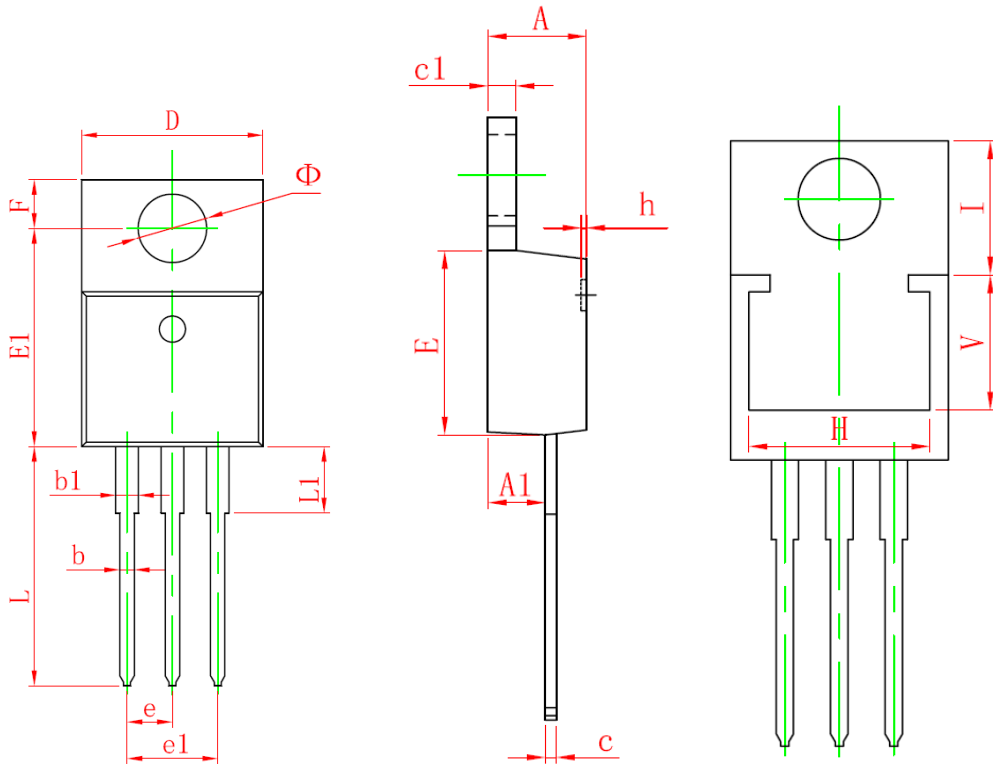

Figure 14 Normalized Maximum Transient Thermal Impedance

### TO-220-3L Package Information



Symbol	Dimensions In Millimeters		Dimensions In Inches	
	Min	Max	Min	Max
A	4.470	4.670	0.176	0.184
A1	2.520	2.820	0.099	0.111
b	0.710	0.910	0.028	0.036
b1	1.170	1.370	0.046	0.054
c	0.330	0.650	0.013	0.026
c1	1.200	1.400	0.047	0.055
D	10.010	10.350	0.394	0.407
E	8.500	8.900	0.335	0.350
E1	12.060	12.460	0.475	0.491
e	2.540 (TYP.)		0.100 (TYP.)	
e1	4.980	5.180	0.196	0.204
F	2.590	2.890	0.102	0.114
H	8.440 REF.		0.332 REF.	
h	0.000	0.300	0.000	0.012
L	13.400	13.800	0.528	0.543
L1	3.560	3.960	0.140	0.156
V	6.360 REF.		0.250 REF.	
I	6.300 REF.		0.248 REF.	
Φ	3.735	3.935	0.147	0.155