

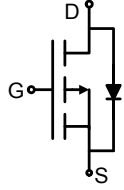
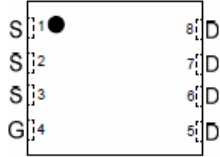

P-Channel Enhancement Mode Power MOSFET

<p>Description</p> <p>The HM20P02Q uses advanced trench technology to provide excellent $R_{DS(ON)}$, low gate charge and operation with gate voltages as low as 2.5V. This device is suitable for use as a load switch or in PWM applications.</p> <p>General Features</p> <ul style="list-style-type: none"> ● $V_{DS} = -20V, I_D = -20A$ ● $R_{DS(ON)} < 28m\Omega @ V_{GS}=-4.5V$ ● $R_{DS(ON)} < 40m\Omega @ V_{GS}=-2.5V$ ● High power and current handling capability ● Lead free product is acquired ● Surface Mount Package <p>Application</p> <ul style="list-style-type: none"> ● Motor drive ● Load switch ● Power management 	<div style="text-align: center;">  <p>Schematic diagram</p>  <p>Pin Assignment</p>  <p>DFN 3.3x3.3 EP top view</p> </div>
--	---

Package Marking And Ordering Information

Device Marking	Device	Device Package	Reel Size	Tape width	Quantity
HM20P02Q	HM20P02Q	DFN3X3-8L	Ø330mm	12mm	2500 units

Absolute Maximum Ratings ($T_A=25^\circ C$ unless otherwise noted)

Parameter	Symbol	Limit	Unit
Drain-Source Voltage	V_{DS}	-20	V
Gate-Source Voltage	V_{GS}	± 12	V
Drain Current-Continuous	I_D	-20	A
Drain Current-Pulsed ^(Note 1)	I_{DM}	-60	A
Maximum Power Dissipation	P_D	3.1	W
Operating Junction and Storage Temperature Range	T_J, T_{STG}	-55 To 150	$^\circ C$

Thermal Characteristic

Thermal Resistance, Junction-to-Ambient ^(Note 2)	$R_{\theta JA}$	42	$^\circ C/W$
---	-----------------	----	--------------

Electrical Characteristics ($T_A=25^\circ C$ unless otherwise noted)

Parameter	Symbol	Condition	Min	Typ	Max	Unit
Off Characteristics						
Drain-Source Breakdown Voltage	BV_{DSS}	$V_{GS}=0V, I_D=-250\mu A$	-20	-	-	V

Zero Gate Voltage Drain Current	I_{DSS}	$V_{DS}=-20V, V_{GS}=0V$	-	-	-1	μA
Gate-Body Leakage Current	I_{GSS}	$V_{GS}=\pm 12V, V_{DS}=0V$	-	-	± 100	nA
On Characteristics (Note 3)						
Gate Threshold Voltage	$V_{GS(th)}$	$V_{DS}=V_{GS}, I_D=-250\mu A$	-0.5	-0.7	-1.4	V
Drain-Source On-State Resistance	$R_{DS(on)}$	$V_{GS}=-4.5V, I_D=-6A$	-	22	28	m Ω
		$V_{GS}=-2.5V, I_D=-5A$		32	40	m Ω
Forward Transconductance	g_{FS}	$V_{DS}=-15V, I_D=-6A$	-	17	-	S
Dynamic Characteristics (Note4)						
Input Capacitance	C_{iss}	$V_{DS}=-10V, V_{GS}=0V,$ $F=1.0MHz$	-	2100	-	PF
Output Capacitance	C_{oss}		-	498	-	PF
Reverse Transfer Capacitance	C_{rss}		-	300	-	PF
Switching Characteristics (Note 4)						
Turn-on Delay Time	$t_{d(on)}$	$V_{DD}=-10V, R_L=10\Omega,$ $V_{GS}=-4.5V, R_{GEN}=6\Omega$	-	25	-	nS
Turn-on Rise Time	t_r		-	30	-	nS
Turn-Off Delay Time	$t_{d(off)}$		-	70	-	nS
Turn-Off Fall Time	t_f		-	50	-	nS
Total Gate Charge	Q_g	$V_{DS}=-10V, I_D=-6A, V_{GS}=-4.5V$	-	17	-	nC
Gate-Source Charge	Q_{gs}		-	4.1	-	nC
Gate-Drain Charge	Q_{gd}		-	4.3	-	nC
Drain-Source Diode Characteristics						
Diode Forward Voltage (Note 3)	V_{SD}	$V_{GS}=0V, I_S=-20A$	-	-	-1.2	V

Notes:

1. Repetitive Rating: Pulse width limited by maximum junction temperature.
2. Surface Mounted on FR4 Board, $t \leq 10$ sec.
3. Pulse Test: Pulse Width $\leq 300\mu s$, Duty Cycle $\leq 2\%$.
4. Guaranteed by design, not subject to production

Typical Electrical and Thermal Characteristics

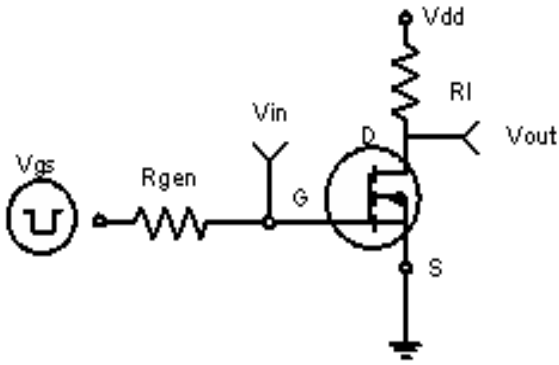

Figure 1 Switching Test Circuit

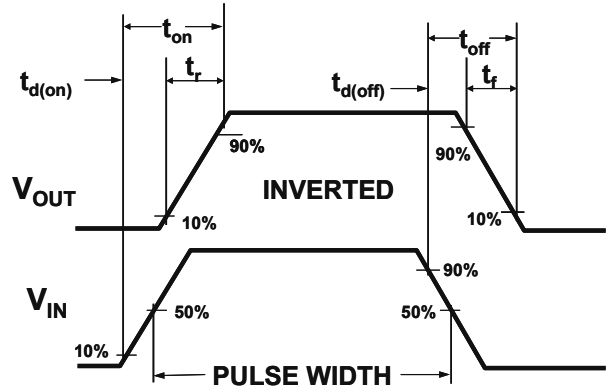

Figure 2 Switching Waveforms

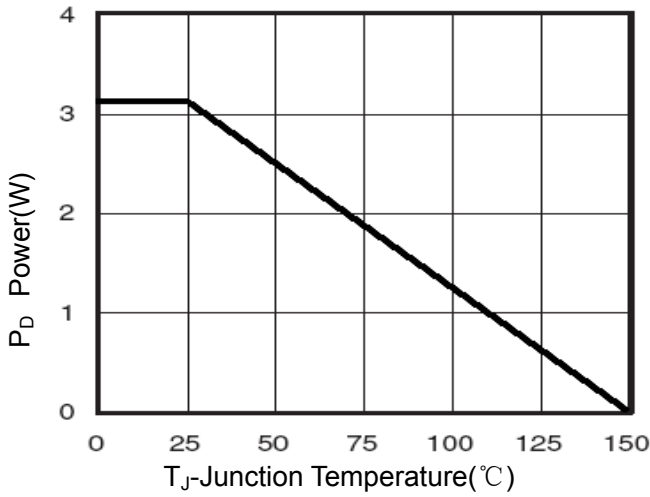

Figure 3 Power Dissipation

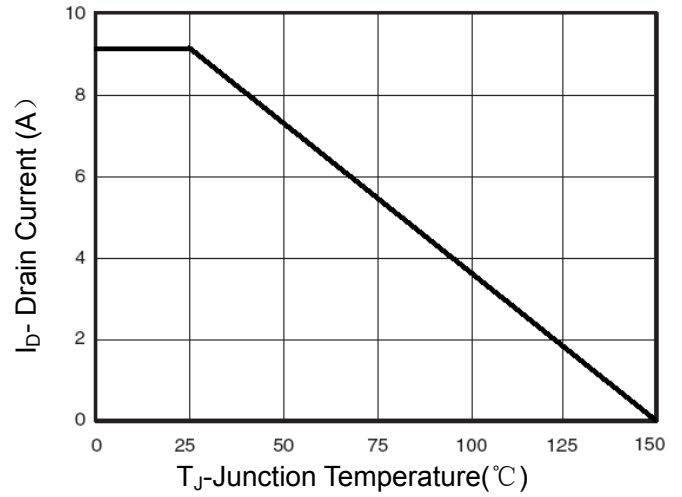

Figure 4 Drain Current

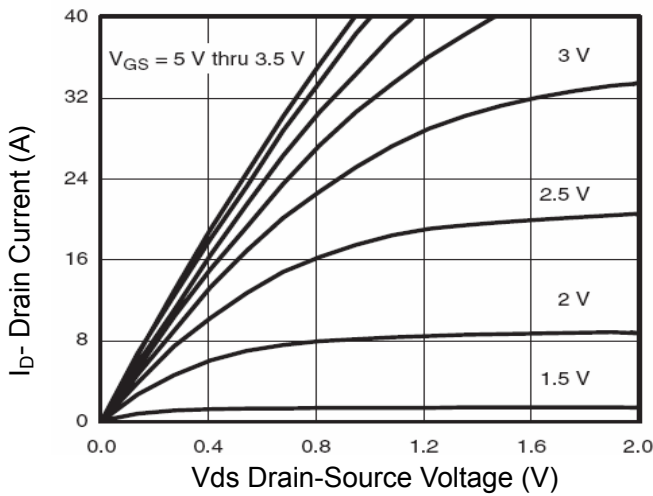

Figure 5 Output Characteristics

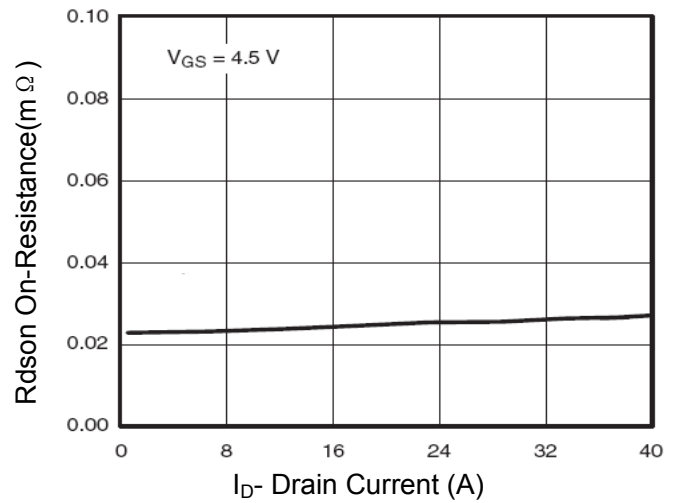

Figure 6 Drain-Source On-Resistance

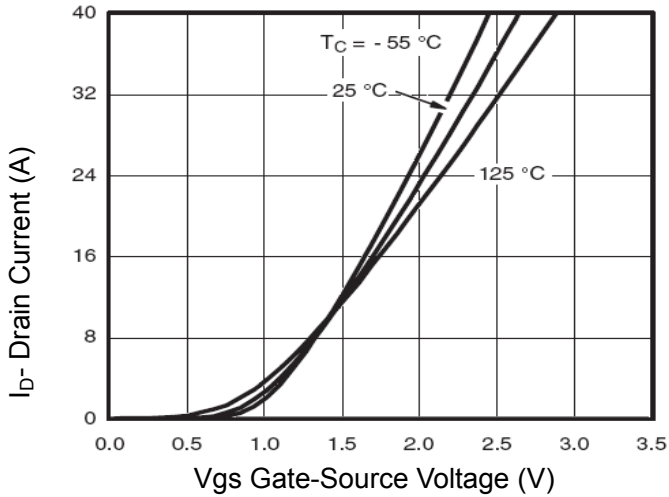

Figure 7 Transfer Characteristics

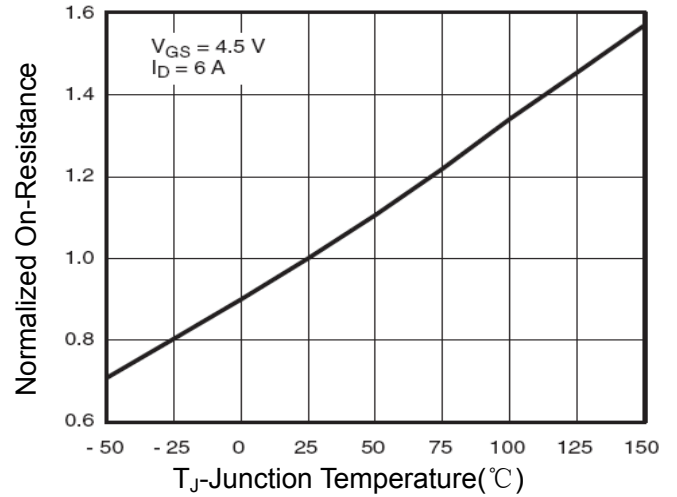

Figure 8 Drain-Source On-Resistance

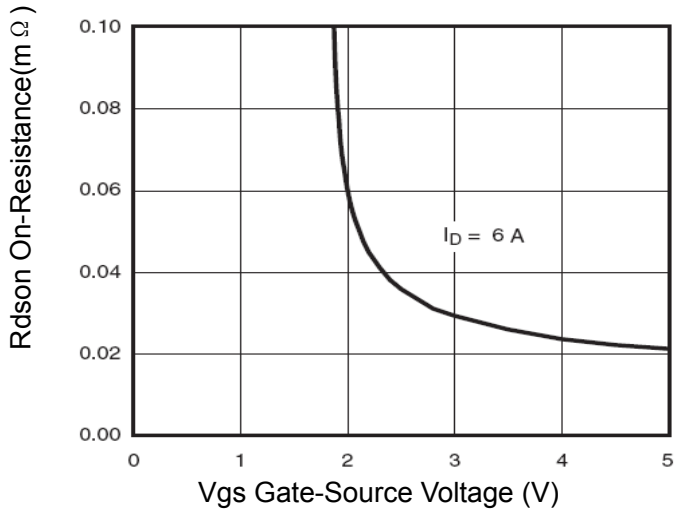

Figure 9 $R_{DS(on)}$ vs V_{GS}

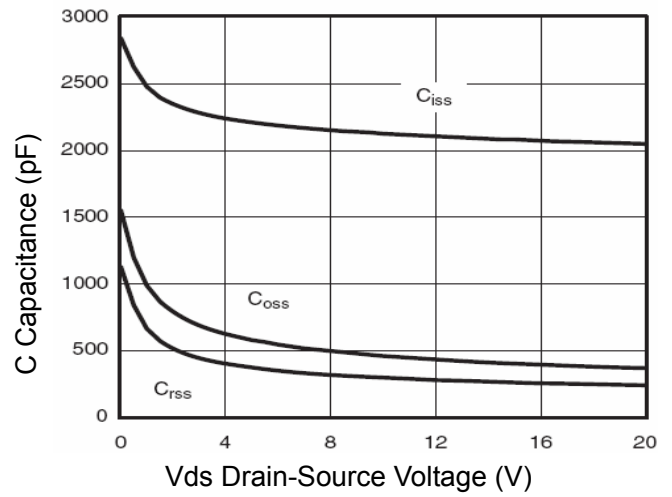

Figure 10 Capacitance vs V_{DS}

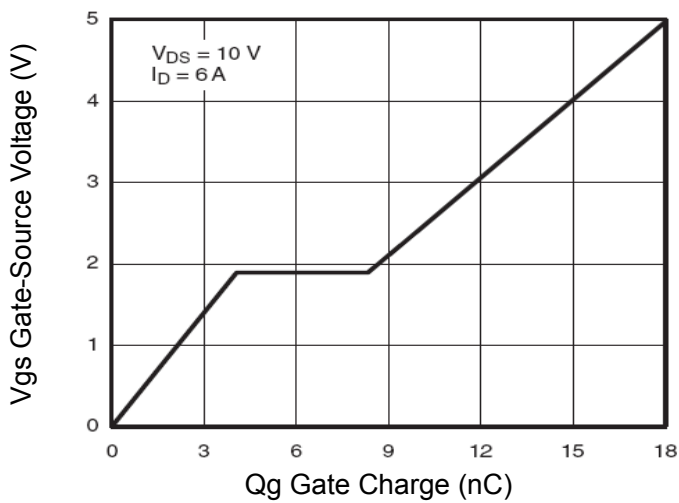

Figure 11 Gate Charge

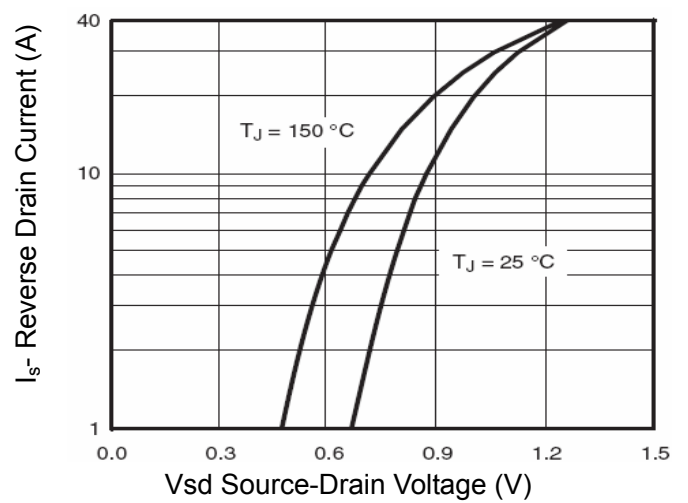

Figure 12 Source- Drain Diode Forward

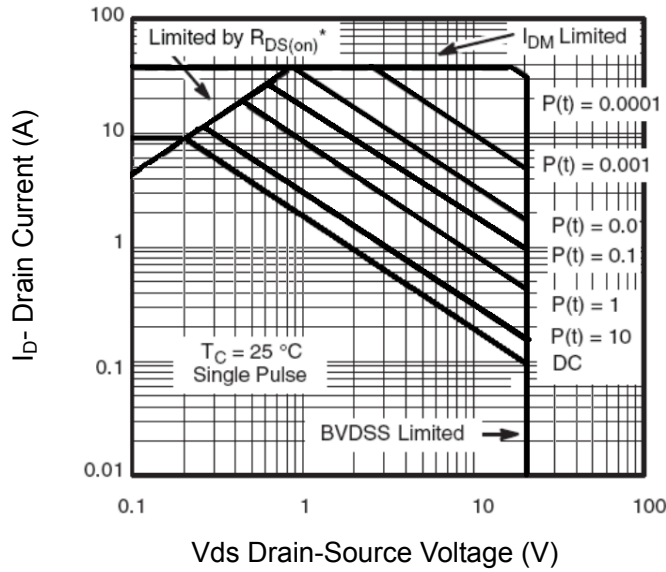

Figure 13 Safe Operation Area

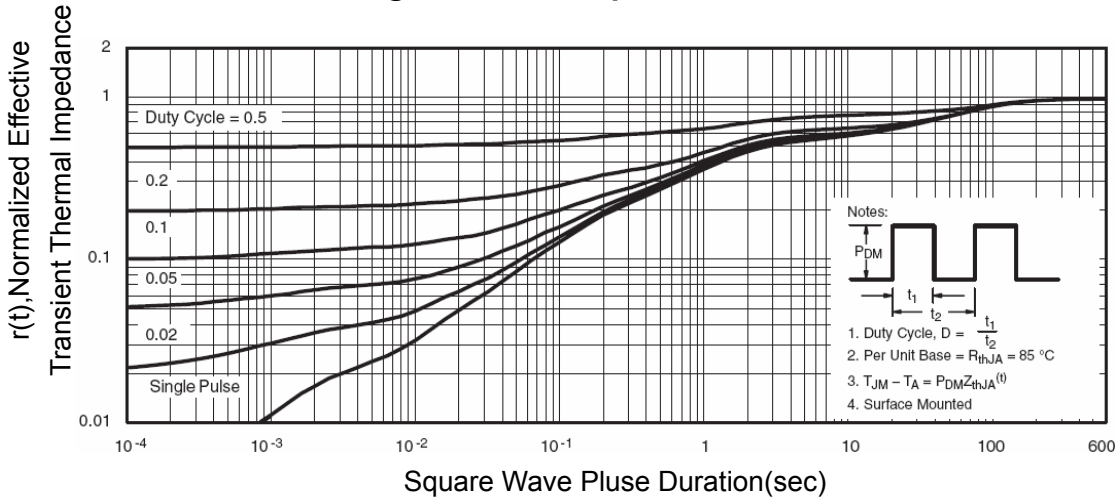
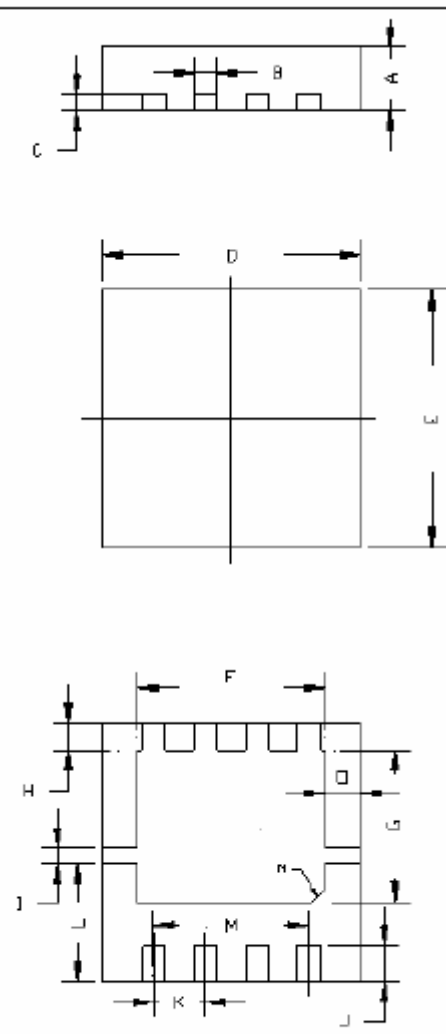

Figure 14 Normalized Maximum Transient Thermal Impedance

DFN3.3X3.3 EP Package Information

封装外形尺寸图				
	符号	单位: mm		
		MIN	MAX	TYP
	A	0.75	0.85	0.8
	B	0.25	0.35	0.3
	C	0.18	0.22	0.2
	D	3.2	3.3	3.25
	E	3.2	3.3	3.25
	F	2.2	2.5	2.35
	G	1.8	2.0	1.9
	H	0.3	0.4	0.35
	I	0.15	0.25	0.2
	J	0.4	0.5	0.45
	K	0.6	0.7	0.65
	L	1.38	1.58	1.48
	M	1.8	2.1	1.95
	N	0.15*45°		
	O	0.4	0.5	0.45