

P-Channel Enhancement Mode Power MOSFET

Description

The HM13P10K uses advanced trench technology and design to provide excellent $R_{DS(ON)}$ with low gate charge. It can be used in a wide variety of applications. It is ESD protested.

General Features

- $V_{DS} = -100V, I_D = -13A$
 $R_{DS(ON)} < 200m\Omega @ V_{GS} = -10V$ (Typ:170m Ω)
- Super high dense cell design
- Advanced trench process technology
- Reliable and rugged
- High density cell design for ultra low on-resistance

Application

- Power switch
- DC/DC converters

100% UIS TESTED!

100% ΔV_{ds} TESTED!

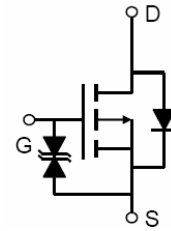

Schematic diagram



Marking and pin assignment

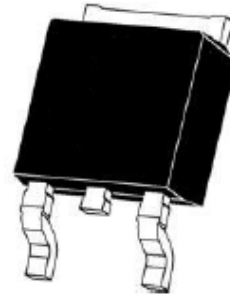

TO-252 -2Ltop view

Package Marking and Ordering Information

Device Marking	Device	Device Package	Reel Size	Tape width	Quantity
HM13P10K	HM13P10K	TO-252-2L	-	-	-

Absolute Maximum Ratings ($T_C = 25^\circ C$ unless otherwise noted)

Parameter	Symbol	Limit	Unit
Drain-Source Voltage	V_{DS}	-100	V
Gate-Source Voltage	V_{GS}	± 20	V
Drain Current-Continuous	I_D	-13	A
Drain Current-Continuous($T_C = 100^\circ C$)	$I_D(100^\circ C)$	-9.2	A
Pulsed Drain Current	I_{DM}	-30	A
Maximum Power Dissipation	P_D	40	W
Derating factor		0.32	W/ $^\circ C$
Single pulse avalanche energy ^(Note 5)	E_{AS}	110	mJ
Operating Junction and Storage Temperature Range	T_J, T_{STG}	-55 To 150	$^\circ C$

Thermal Characteristic

Thermal Resistance, Junction-to-Case (Note 2)	$R_{\theta jc}$	3.13	$^{\circ}\text{C/W}$
---	-----------------	------	----------------------

Electrical Characteristics ($T_C=25^{\circ}\text{C}$ unless otherwise noted)

Parameter	Symbol	Condition	Min	Typ	Max	Unit
Off Characteristics						
Drain-Source Breakdown Voltage	BV_{DSS}	$V_{GS}=0V, I_D=-250\mu A$	-100	-	-	V
Zero Gate Voltage Drain Current	I_{DSS}	$V_{DS}=-100V, V_{GS}=0V$	-	-	1	μA
Gate-Body Leakage Current	I_{GSS}	$V_{GS}=\pm 20V, V_{DS}=0V$	-	-	± 10	μA
On Characteristics (Note 3)						
Gate Threshold Voltage	$V_{GS(th)}$	$V_{DS}=V_{GS}, I_D=-250\mu A$	-1	-1.9	-3	V
Drain-Source On-State Resistance	$R_{DS(ON)}$	$V_{GS}=-10V, I_D=-16A$	-	170	200	m Ω
Forward Transconductance	g_{FS}	$V_{DS}=-15V, I_D=-5A$	12	-	-	S
Dynamic Characteristics (Note 4)						
Input Capacitance	C_{iss}	$V_{DS}=-25V, V_{GS}=0V,$ $F=1.0\text{MHz}$	-	760	-	PF
Output Capacitance	C_{oss}		-	260	-	PF
Reverse Transfer Capacitance	C_{rss}		-	170	-	PF
Switching Characteristics (Note 4)						
Turn-on Delay Time	$t_{d(on)}$	$V_{DD}=-50V, I_D=-10A$ $V_{GS}=-10V, R_{GEN}=9.1\Omega$	-	14	-	nS
Turn-on Rise Time	t_r		-	18	-	nS
Turn-Off Delay Time	$t_{d(off)}$		-	50	-	nS
Turn-Off Fall Time	t_f		-	18	-	nS
Total Gate Charge	Q_g	$V_{DS}=-50V, I_D=-10A,$ $V_{GS}=-10V$	-	25	-	nC
Gate-Source Charge	Q_{gs}		-	5	-	nC
Gate-Drain Charge	Q_{gd}		-	7	-	nC
Drain-Source Diode Characteristics						
Diode Forward Voltage (Note 3)	V_{SD}	$V_{GS}=0V, I_S=-10A$	-	-	-1.2	V
Diode Forward Current (Note 2)	I_S	-	-	-	-13	A
Reverse Recovery Time	t_{rr}	$T_J = 25^{\circ}\text{C}, I_F = -10A$ $di/dt = 100A/\mu s$ (Note 3)	-	35	-	nS
Reverse Recovery Charge	Q_{rr}		-	46	-	nC
Forward Turn-On Time	t_{on}	Intrinsic turn-on time is negligible (turn-on is dominated by LS+LD)				

Notes:

1. Repetitive Rating: Pulse width limited by maximum junction temperature.
2. Surface Mounted on FR4 Board, $t \leq 10$ sec.
3. Pulse Test: Pulse Width $\leq 300\mu s$, Duty Cycle $\leq 2\%$.
4. Guaranteed by design, not subject to production
5. E_{AS} condition: $T_J=25^{\circ}\text{C}, V_{DD}=-50V, V_G=-10V, L=0.5\text{mH}, R_g=25\Omega$

Test Circuit

1) E_{AS} Test Circuit

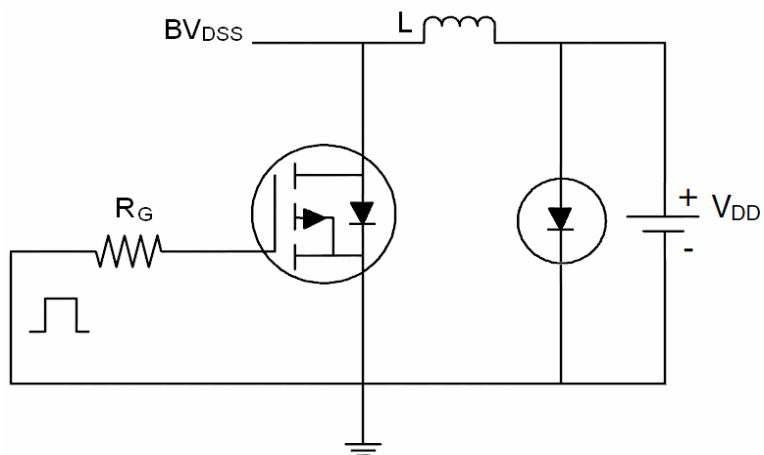

2) Gate Charge Test Circuit

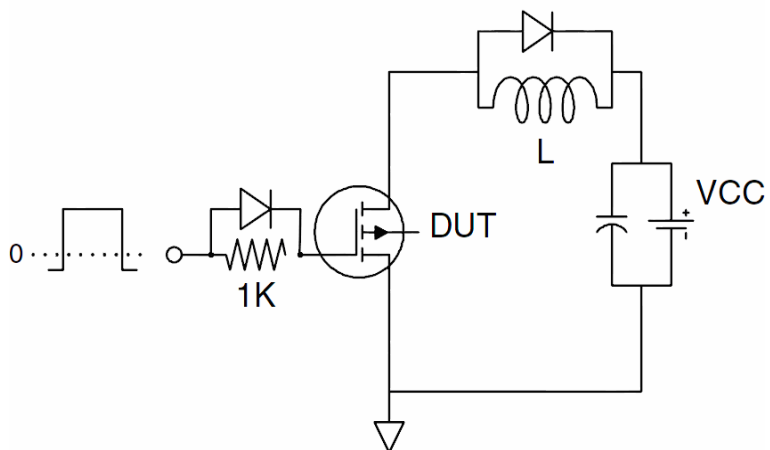

3) Switch Time Test Circuit

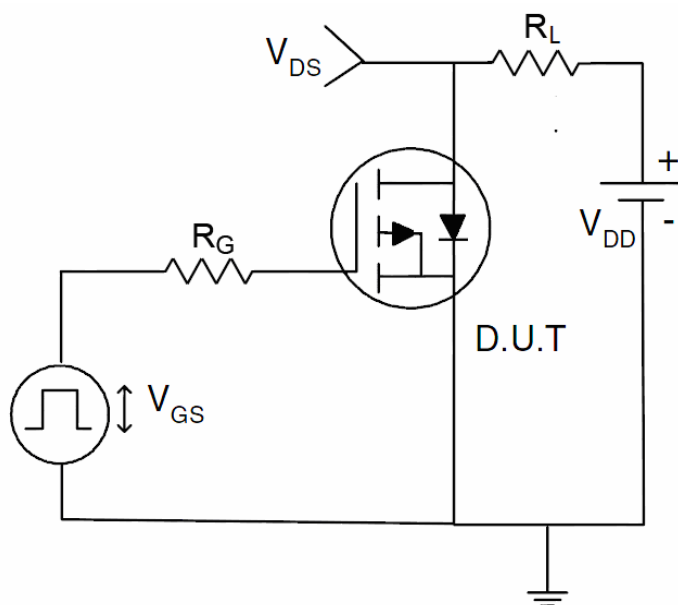

Typical Electrical and Thermal Characteristics (Curves)

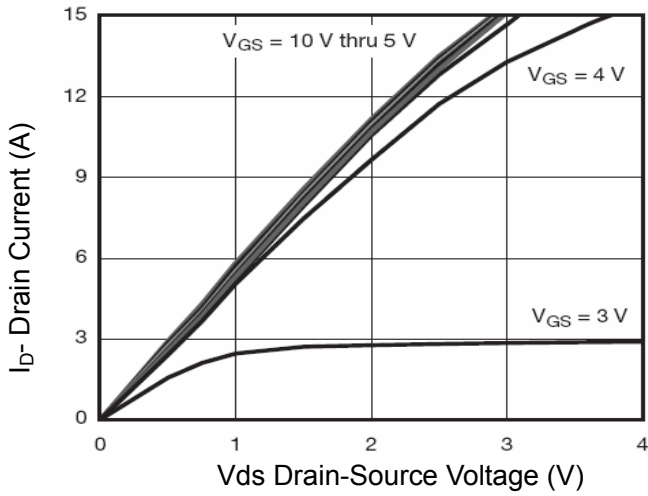

Figure 1 Output Characteristics

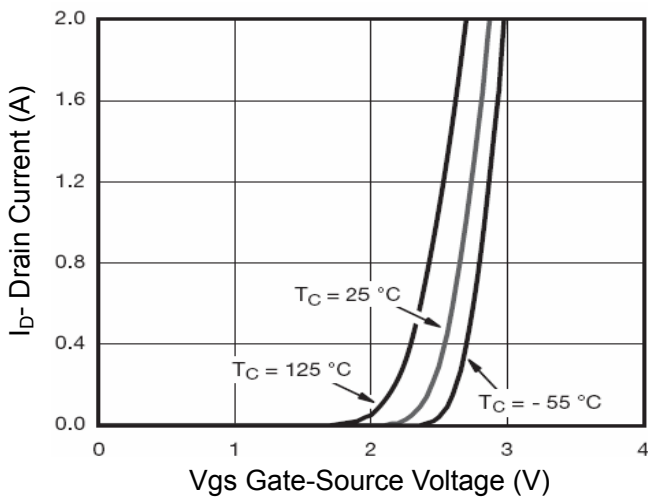

Figure 2 Transfer Characteristics

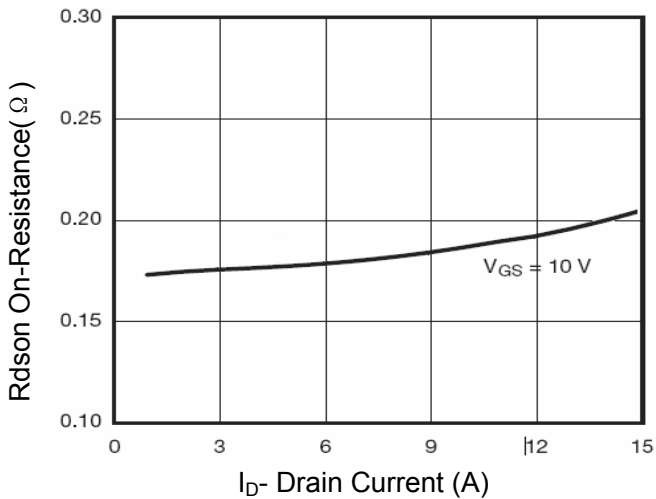

Figure 3 Rdson- Drain Current

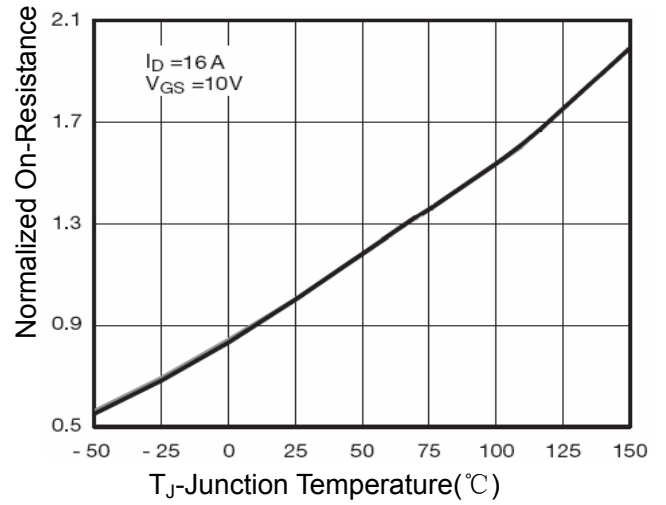

Figure 4 Rdson-Junction Temperature

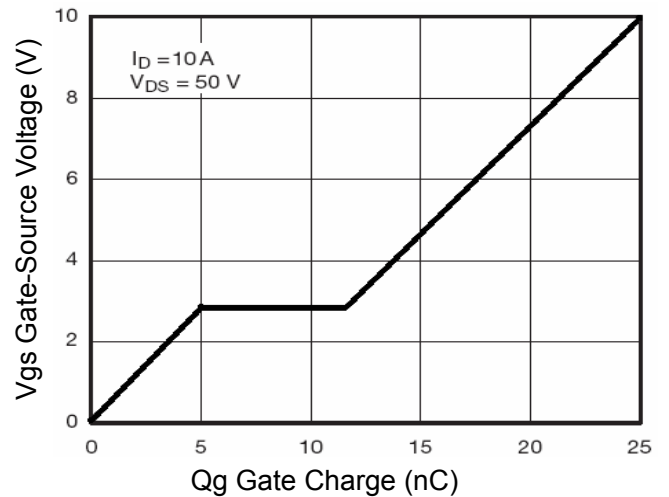

Figure 5 Gate Charge

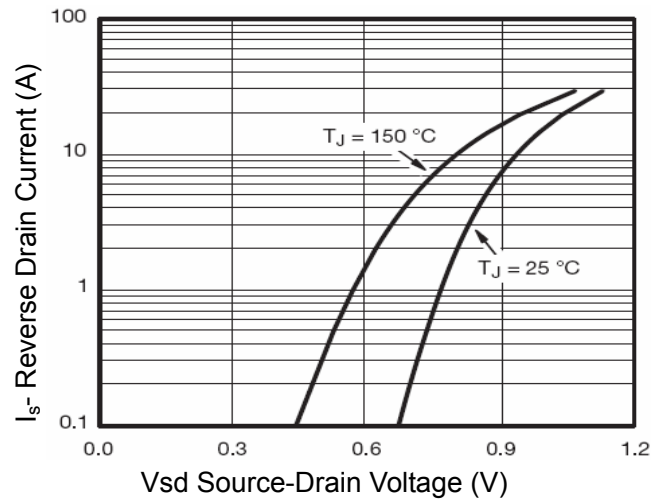

Figure 6 Source- Drain Diode Forward

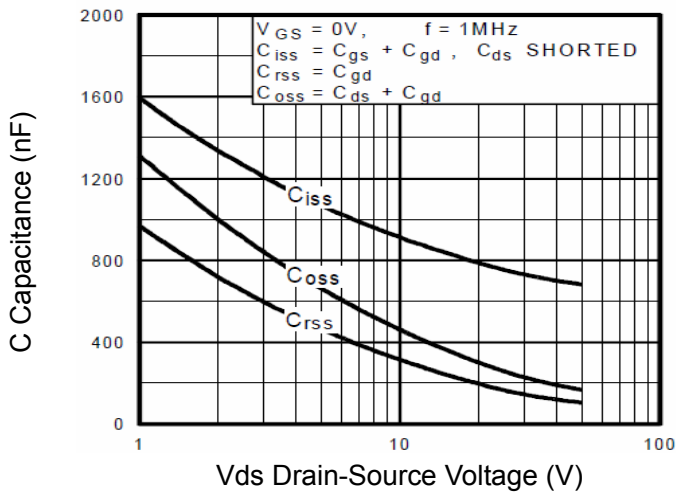

Figure 7 Capacitance vs Vds

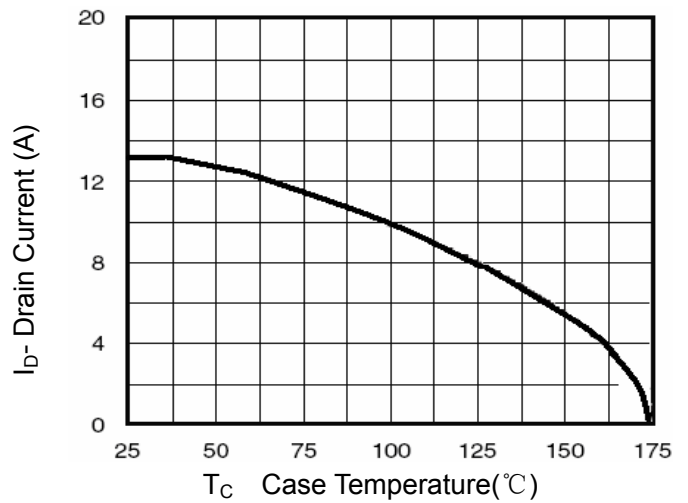

Figure 9 Drain Current vs Case Temperature

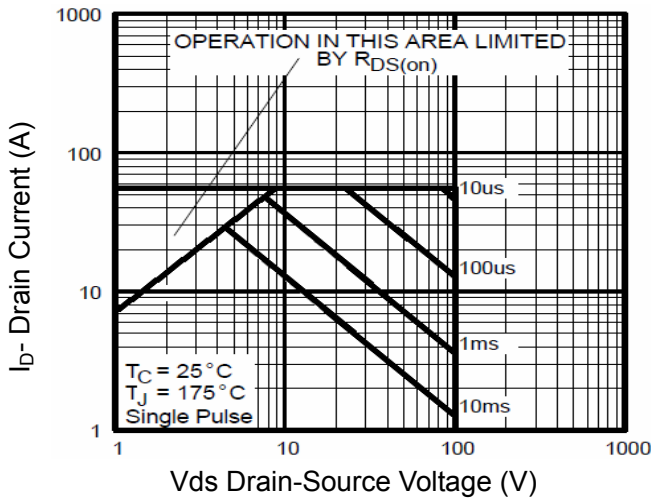

Figure 8 Safe Operation Area

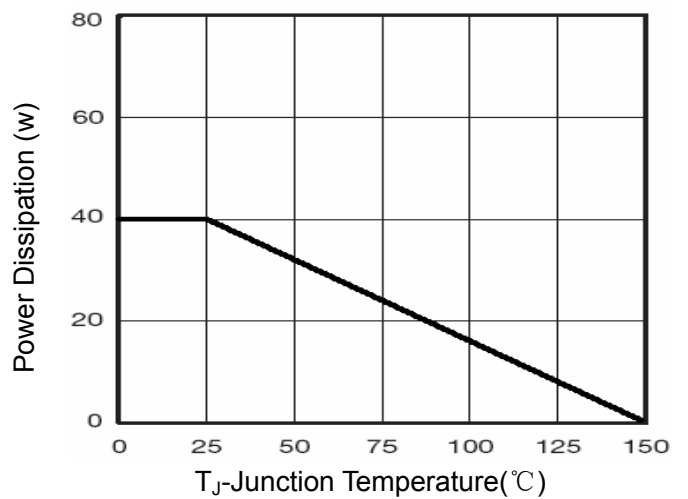

Figure 10 Power De-rating

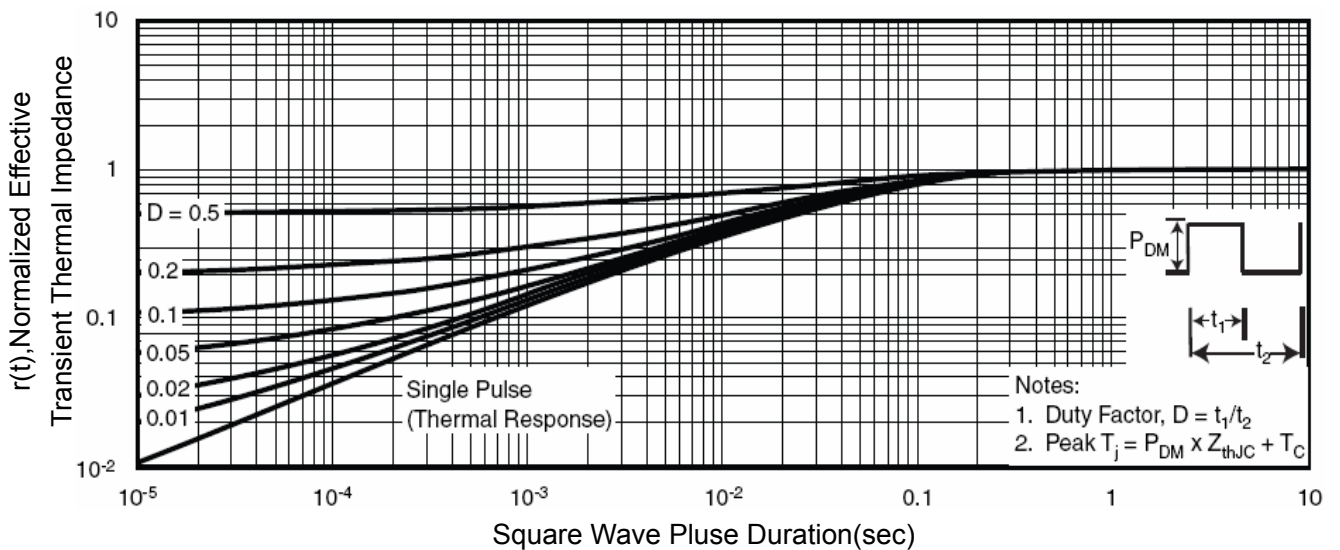
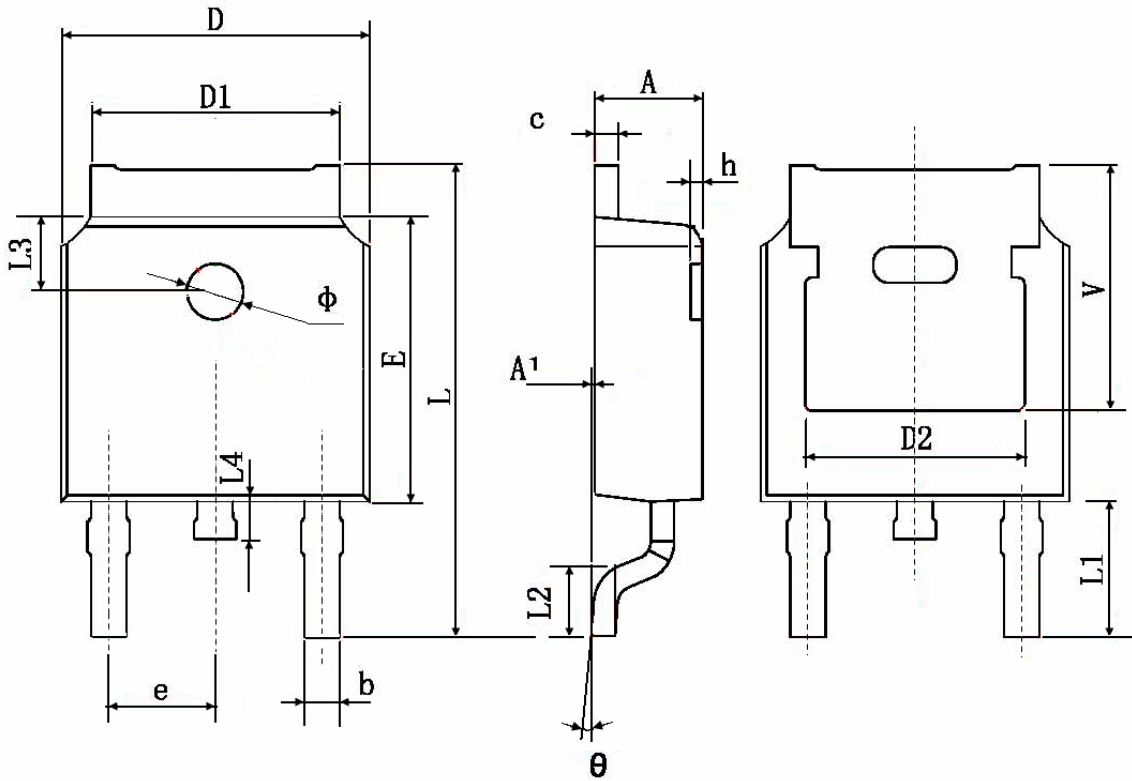

Figure 11 Normalized Maximum Transient Thermal Impedance

TO-252 Package Information



Symbol	Dimensions In Millimeters		Dimensions In Inches	
	Min.	Max.	Min.	Max.
A	2.200	2.400	0.087	0.094
A1	0.000	0.127	0.000	0.005
b	0.660	0.860	0.026	0.034
c	0.460	0.580	0.018	0.023
D	6.500	6.700	0.256	0.264
D1	5.100	5.460	0.201	0.215
D2	4.830 TYP.		0.190 TYP.	
E	6.000	6.200	0.236	0.244
e	2.186	2.386	0.086	0.094
L	9.800	10.400	0.386	0.409
L1	2.900 TYP.		0.114 TYP.	
L2	1.400	1.700	0.055	0.067
L3	1.600 TYP.		0.063 TYP.	
L4	0.600	1.000	0.024	0.039
Φ	1.100	1.300	0.043	0.051
θ	0°	8°	0°	8°
h	0.000	0.300	0.000	0.012
V	5.350 TYP.		0.211 TYP.	