

Description

The HM100P35E uses advanced trench technology to provide excellent $R_{DS(ON)}$. This device is suitable for use as a load switch or power management.

General Features

- $V_{DS} = -35V, I_D = -100A$
 $R_{DS(ON)} < 7.2m\Omega @ V_{GS} = -10V$
- High power and current handling capability
- Lead free product is acquired
- Surface mount package

Application

- Power management
- Load switch

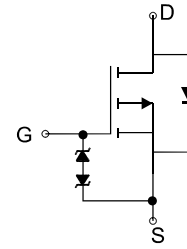

Schematic diagram

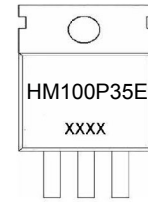

Marking and pin assignment

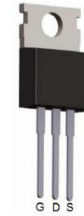

TO-220-3L top view

Package Marking and Ordering Information

Device Marking	Device	Device Package	Reel Size	Tape width	Quantity
HM100P35E	HM100P35E	TO-220-3L	Ø330mm	12mm	2500 units

Absolute Maximum Ratings ($T_A = 25^\circ C$ unless otherwise noted)

Parameter	Symbol	Limit	Unit
Drain-Source Voltage	V_{DS}	-35	V
Gate-Source Voltage	V_{GS}	± 20	V
Drain Current-Continuous	I_D	-100	A
Drain Current-Pulsed (Note 1)	I_{DM}	-300	A
Maximum Power Dissipation	P_D	75	W
Operating Junction and Storage Temperature Range	T_J, T_{STG}	-55 To 150	$^\circ C$

Thermal Characteristic

Thermal Resistance, Junction-to-Ambient (Note 2)	$R_{\theta JA}$	36	$^\circ C/W$
--	-----------------	----	--------------

Electrical Characteristics ($T_A = 25^\circ C$ unless otherwise noted)

Parameter	Symbol	Condition	Min	Typ	Max	Unit
Off Characteristics						
Drain-Source Breakdown Voltage	BV_{DSS}	$V_{GS} = 0V, I_D = -250\mu A$	-35	-33	-	V
Zero Gate Voltage Drain Current	I_{DSS}	$V_{DS} = -35V, V_{GS} = 0V$	-	-	-1	μA

Gate-Body Leakage Current	I_{GSS}	$V_{GS}=\pm 20V, V_{DS}=0V$	-	-	± 100	nA
On Characteristics (Note 3)						
Gate Threshold Voltage	$V_{GS(th)}$	$V_{DS}=V_{GS}, I_D=-250\mu A$	-1.0	-	-3.0	V
Drain-Source On-State Resistance	$R_{DS(ON)}$	$V_{GS}=-10V, I_D=-30A$	-	5.5	7.2	m Ω
Forward Transconductance	g_{FS}	$V_{DS}=-10V, I_D=-30A$	30	-	-	S
Dynamic Characteristics (Note4)						
Input Capacitance	C_{ISS}	$V_{DS}=-15V, V_{GS}=0V,$ $F=1.0MHz$	-	3960	-	PF
Output Capacitance	C_{OSS}		-	486	-	PF
Reverse Transfer Capacitance	C_{RSS}		-	268	-	PF
Switching Characteristics (Note 4)						
Turn-on Delay Time	$t_{d(on)}$	$V_{DD}=-15V, I_D=-20A,$ $V_{GS}=-10V, R_{GEN}=3\Omega$	-	20	-	nS
Turn-on Rise Time	t_r		-	13	-	nS
Turn-Off Delay Time	$t_{d(off)}$		-	55	-	nS
Turn-Off Fall Time	t_f		-	21	-	nS
Total Gate Charge	Q_g	$V_{DS}=-15V, I_D=-20A, V_{GS}=-10V$	-	65	-	nC
Gate-Source Charge	Q_{gs}		-	12	-	nC
Gate-Drain Charge	Q_{gd}		-	14	-	nC
Drain-Source Diode Characteristics						
Diode Forward Voltage (Note 3)	V_{SD}	$V_{GS}=0V, I_S=-50A$	-	-	-1.2	V

Notes

1. Repetitive Rating: Pulse width limited by maximum junction temperature.
2. Surface Mounted on FR4 Board, $t \leq 10$ sec.
3. Pulse Test: Pulse Width $\leq 300\mu s$, Duty Cycle $\leq 2\%$.
4. Guaranteed by design, not subject to production

Typical Electrical and Thermal Characteristics



Figure 1 Switching Test Circuit

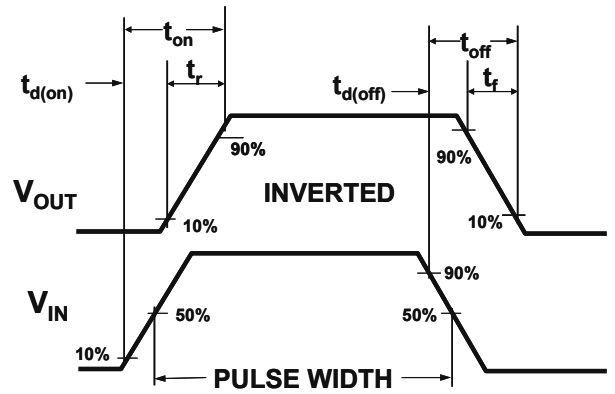

Figure 2 Switching Waveforms

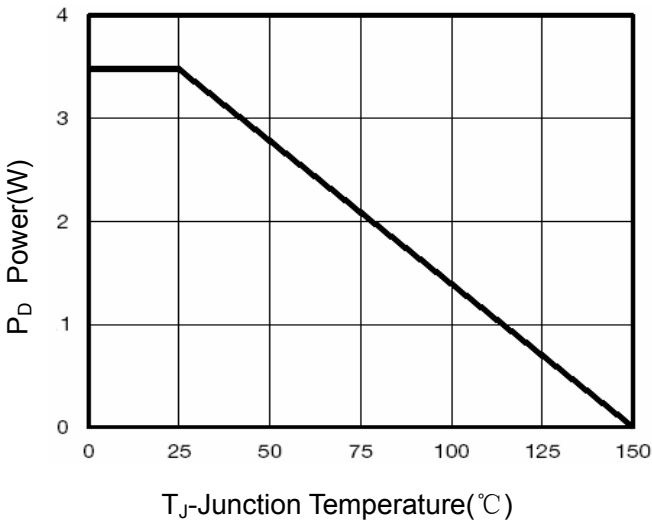

Figure 3 Power Dissipation

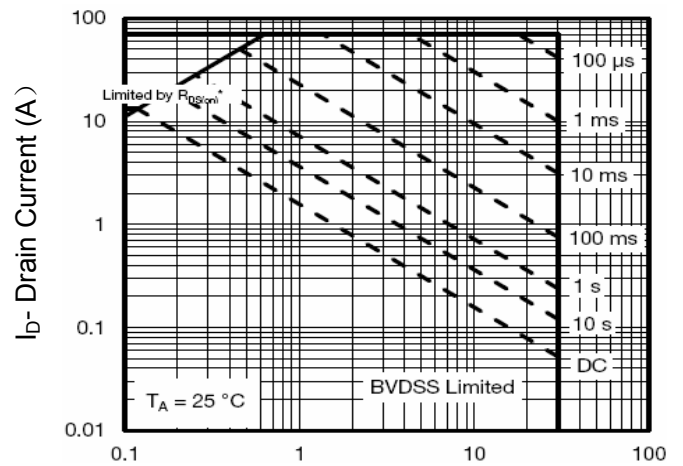

Figure 4 Safe Operation Area

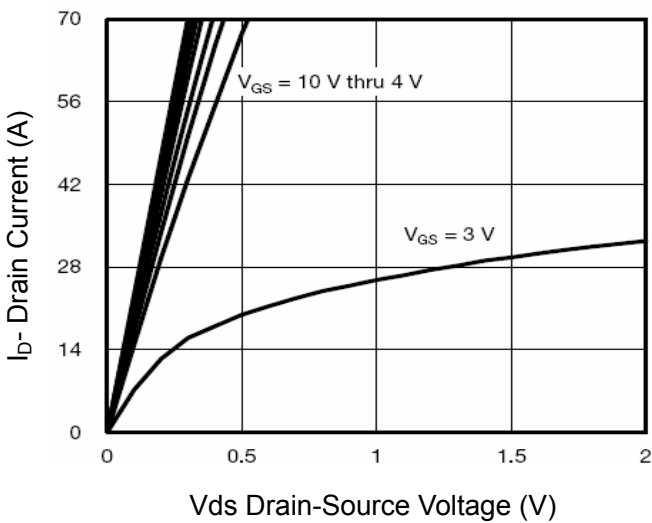

Figure 5 Output Characteristics

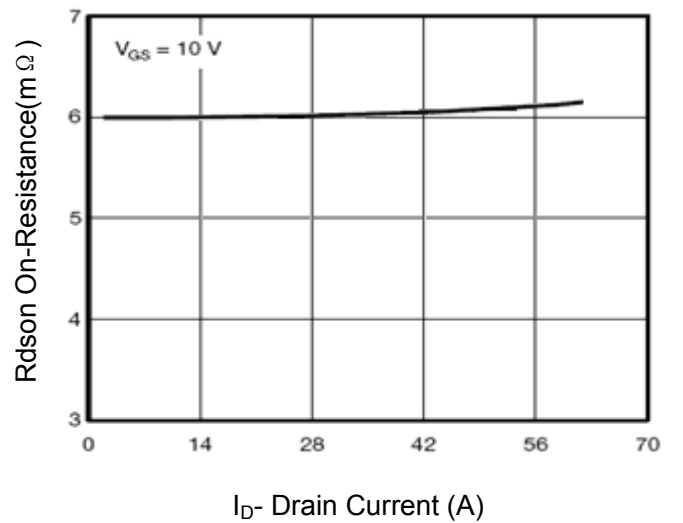

Figure 6 Drain-Source On-Resistance

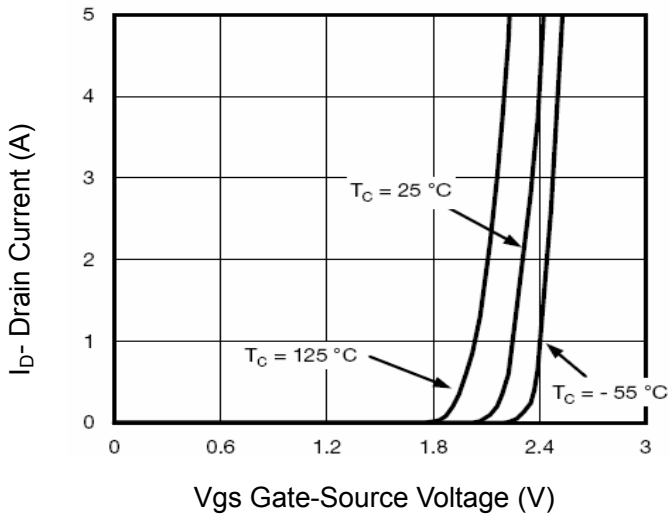

Figure 7 Transfer Characteristics

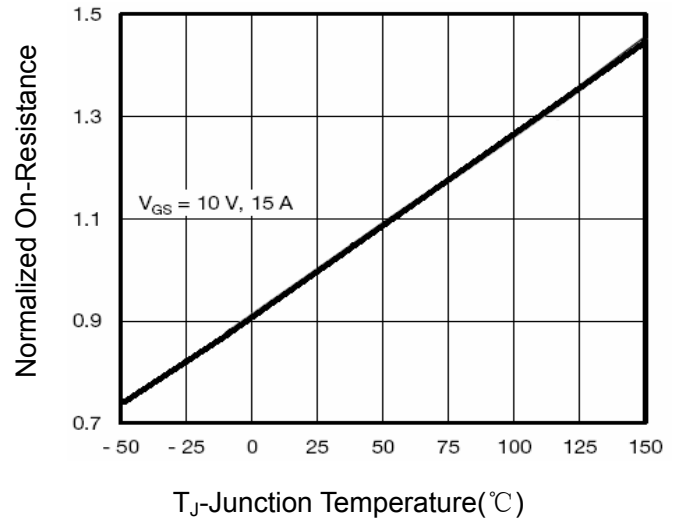

Figure 8 Drain-Source On-Resistance

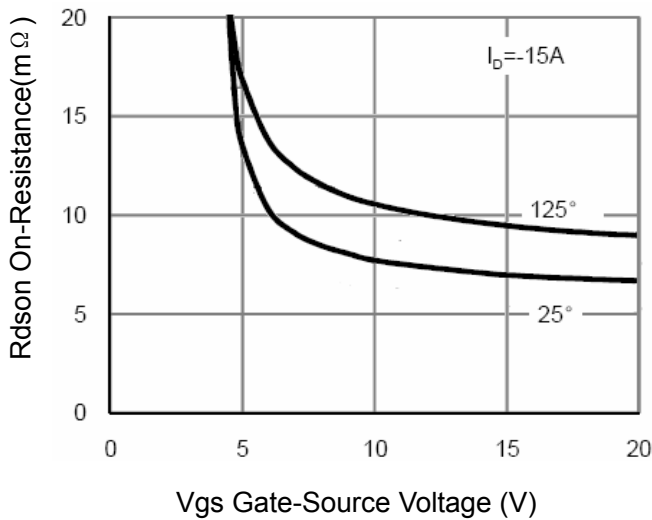

Figure 9 $R_{DS(on)}$ vs V_{GS}

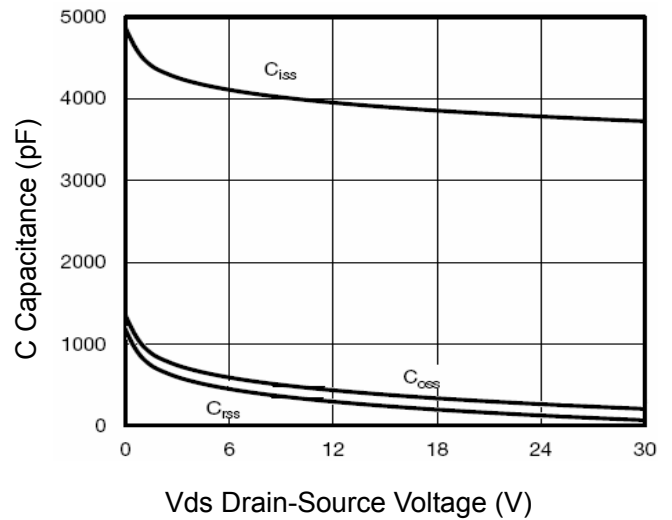

Figure 10 Capacitance vs V_{DS}

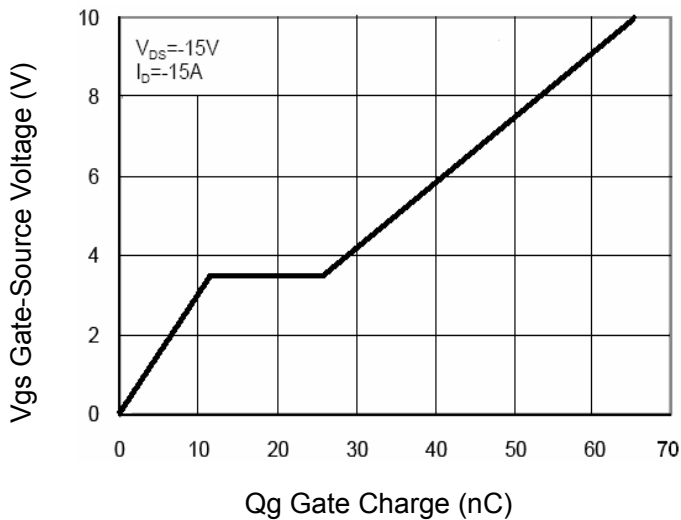

Figure 11 Gate Charge

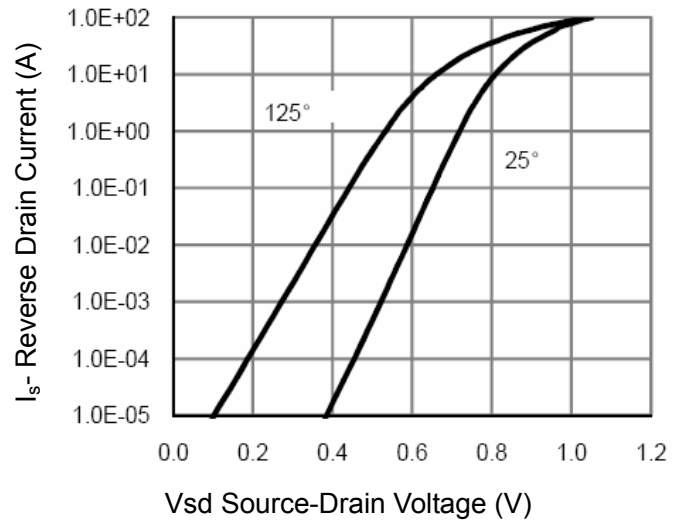

Figure 12 Source- Drain Diode Forward

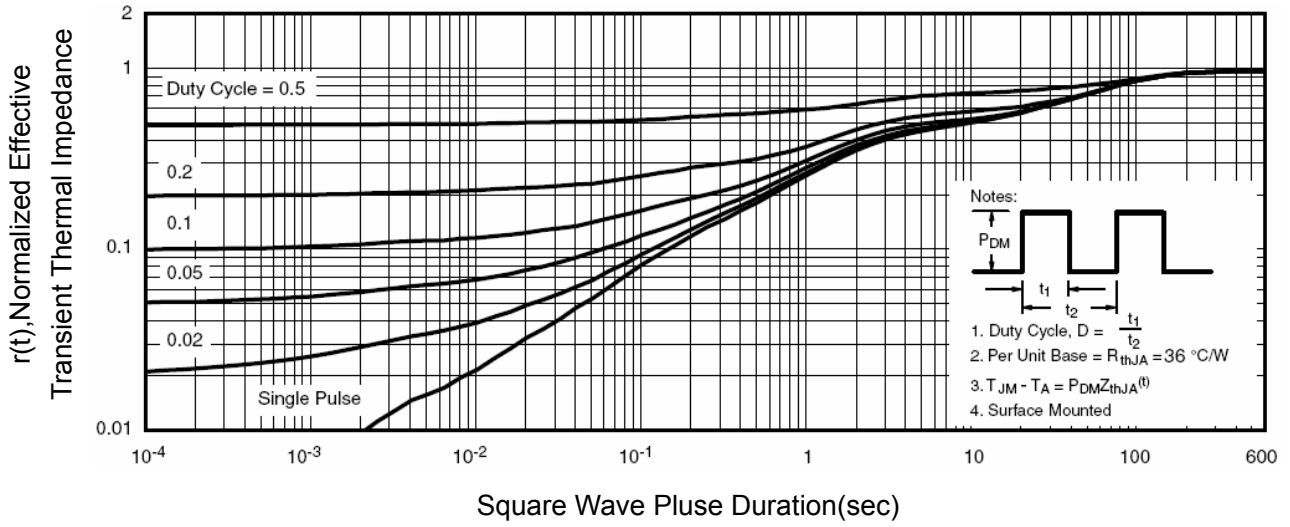
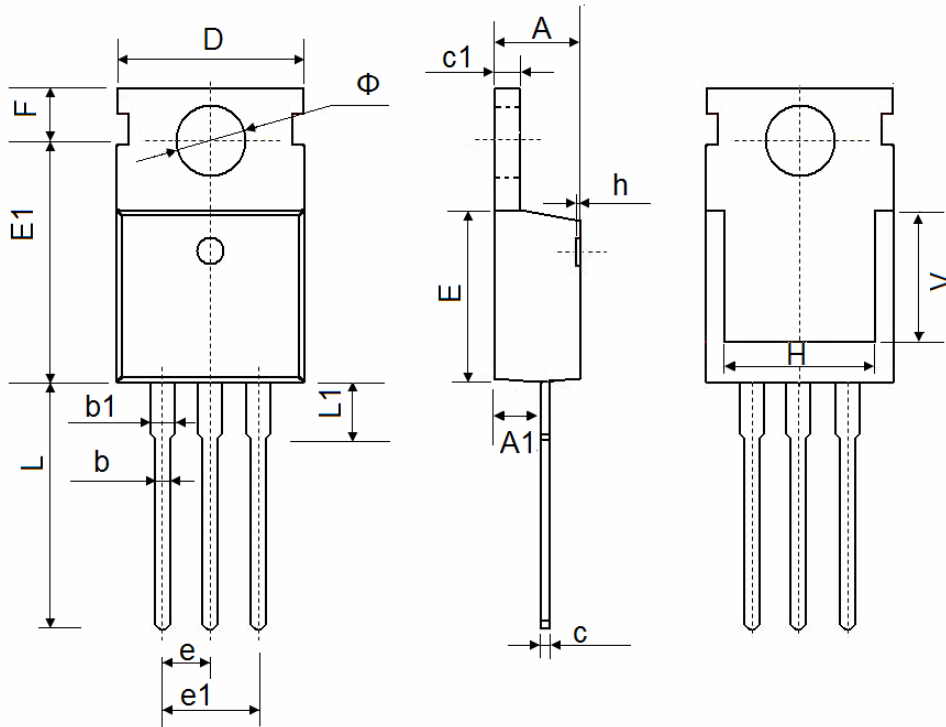

Figure 13 Normalized Maximum Transient Thermal Impedance

TO-220-3L Package Information



Symbol	Dimensions In Millimeters		Dimensions In Inches	
	Min.	Max.	Min.	Max.
A	4.400	4.600	0.173	0.181
A1	2.250	2.550	0.089	0.100
b	0.710	0.910	0.028	0.036
b1	1.170	1.370	0.046	0.054
c	0.330	0.650	0.013	0.026
c1	1.200	1.400	0.047	0.055
D	9.910	10.250	0.390	0.404
E	8.9500	9.750	0.352	0.384
E1	12.650	12.950	0.498	0.510
e	2.540 TYP.		0.100 TYP.	
e1	4.980	5.180	0.196	0.204
F	2.650	2.950	0.104	0.116
H	7.900	8.100	0.311	0.319
h	0.000	0.300	0.000	0.012
L	12.900	13.400	0.508	0.528
L1	2.850	3.250	0.112	0.128
V	7.500 REF.		0.295 REF.	
Φ	3.400	3.800	0.134	0.150