

### Description

The HM100P03 uses advanced trench technology to provide excellent  $R_{DS(ON)}$ . This device is suitable for use as a load switch or power management.

### General Features

- $V_{DS} = -30V, I_D = -100A$   
 $R_{DS(ON)} < 6m\Omega @ V_{GS} = -10V$   
 $R_{DS(ON)} < 8m\Omega @ V_{GS} = -4.5V$
- High power and current handling capability
- Lead free product is acquired
- Surface mount package

### Application

- Power management
- Load switch

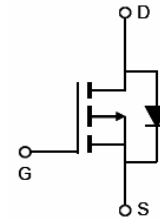

Schematic diagram

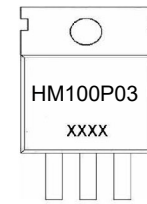

Marking and pin assignment

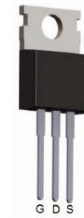

TO-220-3L top view

### Package Marking and Ordering Information

Device Marking	Device	Device Package	Reel Size	Tape width	Quantity
HM100P03	HM100P03	TO-220-3L	Ø330mm	12mm	2500 units

### Absolute Maximum Ratings ( $T_A = 25^\circ C$ unless otherwise noted)

Parameter	Symbol	Limit	Unit
Drain-Source Voltage	$V_{DS}$	-30	V
Gate-Source Voltage	$V_{GS}$	$\pm 20$	V
Drain Current-Continuous	$I_D$	-100	A
Drain Current-Pulsed (Note 1)	$I_{DM}$	-300	A
Maximum Power Dissipation	$P_D$	75	W
Operating Junction and Storage Temperature Range	$T_J, T_{STG}$	-55 To 150	$^\circ C$

### Thermal Characteristic

Thermal Resistance, Junction-to-Ambient (Note 2)	$R_{\theta JA}$	36	$^\circ C/W$
--	-----------------	----	--------------

### Electrical Characteristics ( $T_A = 25^\circ C$ unless otherwise noted)

Parameter	Symbol	Condition	Min	Typ	Max	Unit
<b>Off Characteristics</b>						
Drain-Source Breakdown Voltage	$BV_{DSS}$	$V_{GS} = 0V, I_D = -250\mu A$	-30	-33	-	V
Zero Gate Voltage Drain Current	$I_{DSS}$	$V_{DS} = -30V, V_{GS} = 0V$	-	-	-1	$\mu A$

Gate-Body Leakage Current	$I_{GSS}$	$V_{GS}=\pm 20V, V_{DS}=0V$	-	-	$\pm 100$	nA
<b>On Characteristics</b> (Note 3)						
Gate Threshold Voltage	$V_{GS(th)}$	$V_{DS}=V_{GS}, I_D=-250\mu A$	-1.0	-	-2.5	V
Drain-Source On-State Resistance	$R_{DS(ON)}$	$V_{GS}=-10V, I_D=-30A$	-	4.5	6	m $\Omega$
		$V_{GS}=-4.5V, I_D=-15A$	-	6	8	m $\Omega$
Forward Transconductance	$g_{FS}$	$V_{DS}=-10V, I_D=-30A$	30	-	-	S
<b>Dynamic Characteristics</b> (Note4)						
Input Capacitance	$C_{ISS}$	$V_{DS}=-15V, V_{GS}=0V,$ $F=1.0MHz$	-	3960	-	PF
Output Capacitance	$C_{OSS}$		-	486	-	PF
Reverse Transfer Capacitance	$C_{RSS}$		-	268	-	PF
<b>Switching Characteristics</b> (Note 4)						
Turn-on Delay Time	$t_{d(on)}$	$V_{DD}=-15V, I_D=-20A,$ $V_{GS}=-10V, R_{GEN}=3\Omega$	-	20	-	nS
Turn-on Rise Time	$t_r$		-	13	-	nS
Turn-Off Delay Time	$t_{d(off)}$		-	55	-	nS
Turn-Off Fall Time	$t_f$		-	21	-	nS
Total Gate Charge	$Q_g$	$V_{DS}=-15V, I_D=-20A, V_{GS}=-10V$	-	65	-	nC
Gate-Source Charge	$Q_{gs}$		-	12	-	nC
Gate-Drain Charge	$Q_{gd}$		-	14	-	nC
<b>Drain-Source Diode Characteristics</b>						
Diode Forward Voltage (Note 3)	$V_{SD}$	$V_{GS}=0V, I_S=-50A$	-	-	-1.2	V

**Notes**

1. Repetitive Rating: Pulse width limited by maximum junction temperature.
2. Surface Mounted on FR4 Board,  $t \leq 10$  sec.
3. Pulse Test: Pulse Width  $\leq 300\mu s$ , Duty Cycle  $\leq 2\%$ .
4. Guaranteed by design, not subject to production

Typical Electrical and Thermal Characteristics



Figure 1 Switching Test Circuit

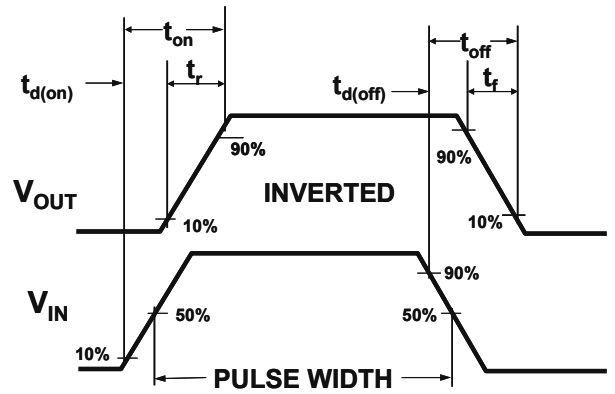

Figure 2 Switching Waveforms

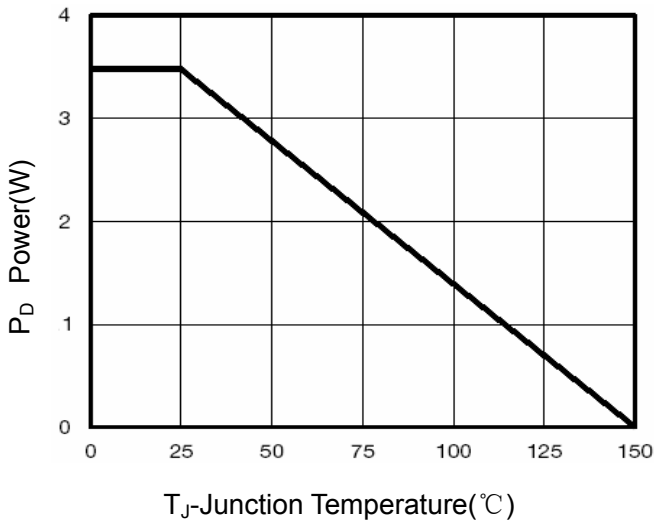

Figure 3 Power Dissipation

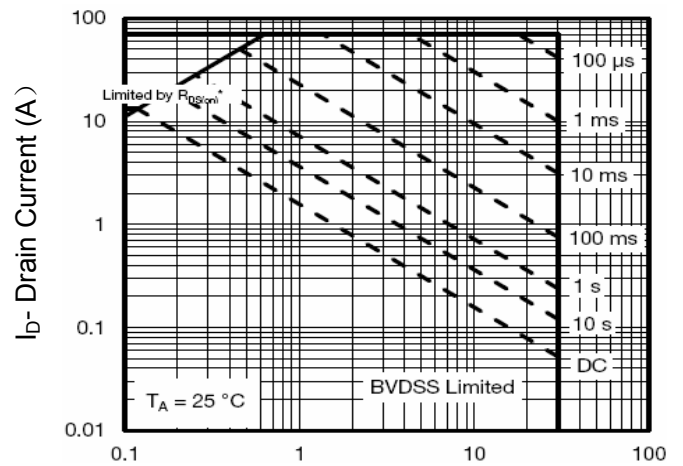

Figure 4 Safe Operation Area

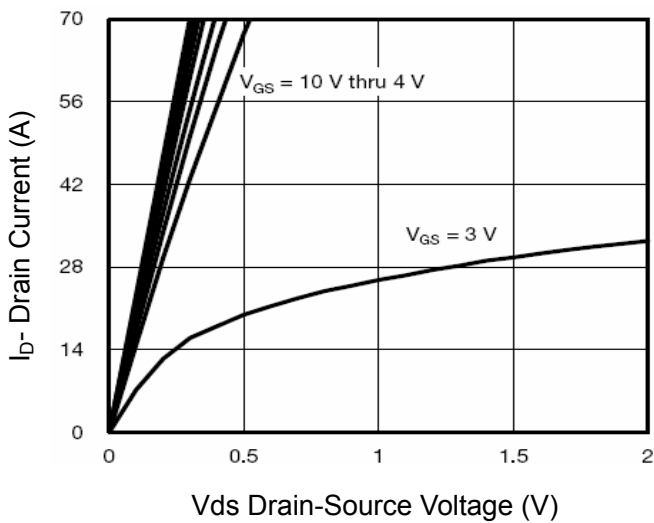

Figure 5 Output Characteristics

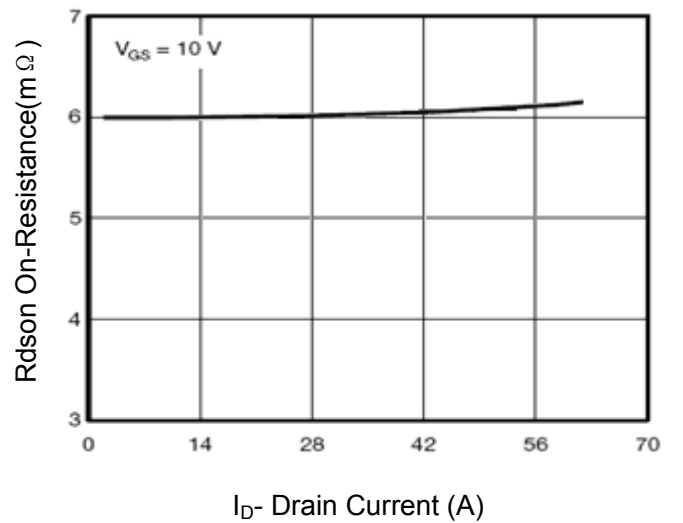

Figure 6 Drain-Source On-Resistance

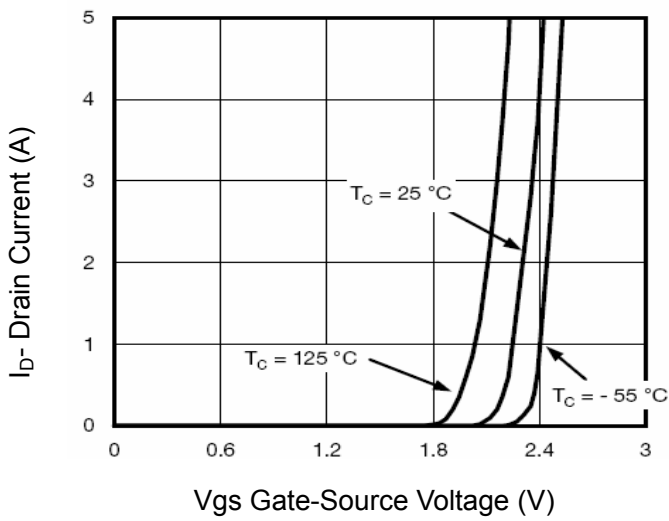

Figure 7 Transfer Characteristics

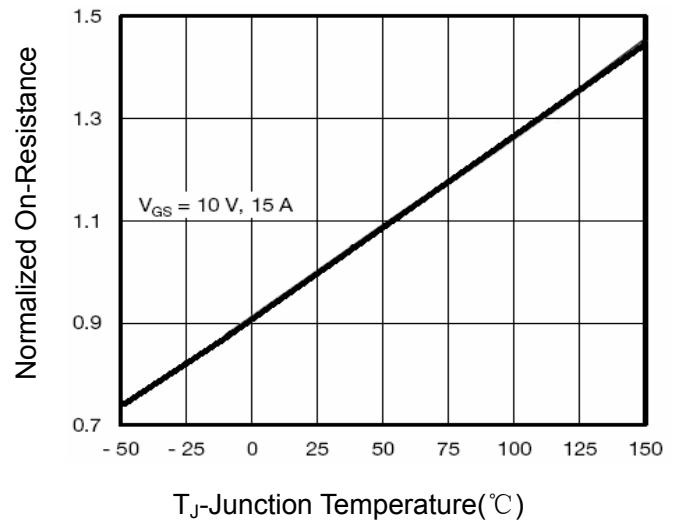

Figure 8 Drain-Source On-Resistance

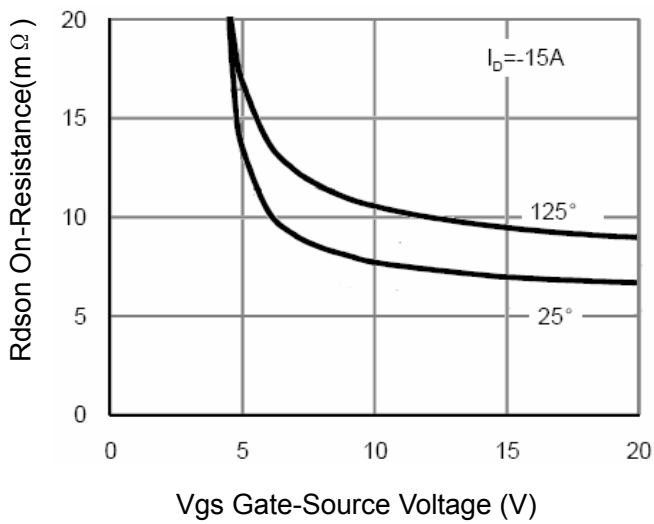

Figure 9  $R_{DS(on)}$  vs  $V_{GS}$

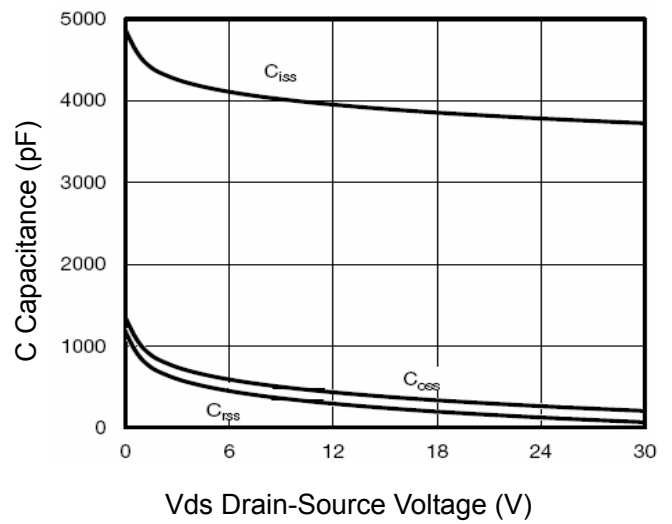

Figure 10 Capacitance vs  $V_{DS}$

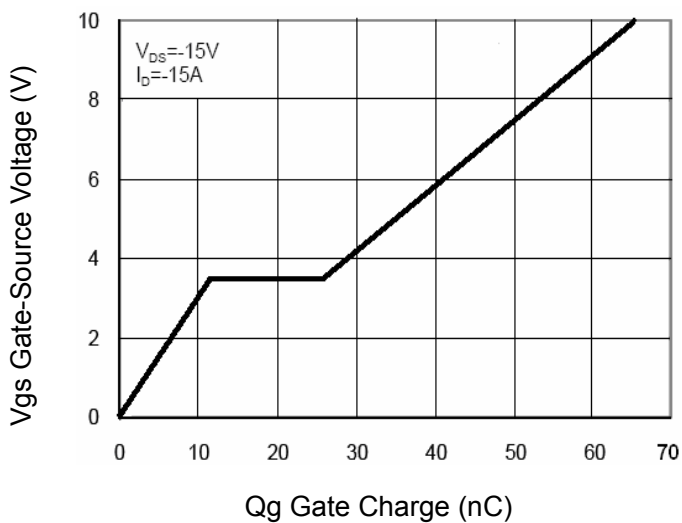

Figure 11 Gate Charge

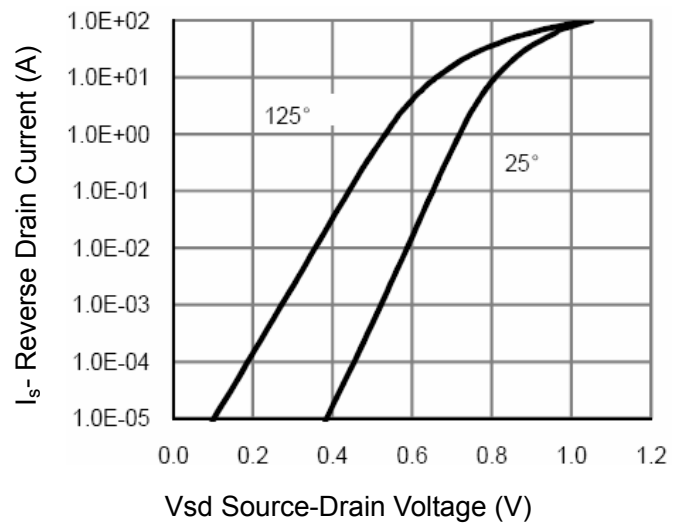

Figure 12 Source- Drain Diode Forward

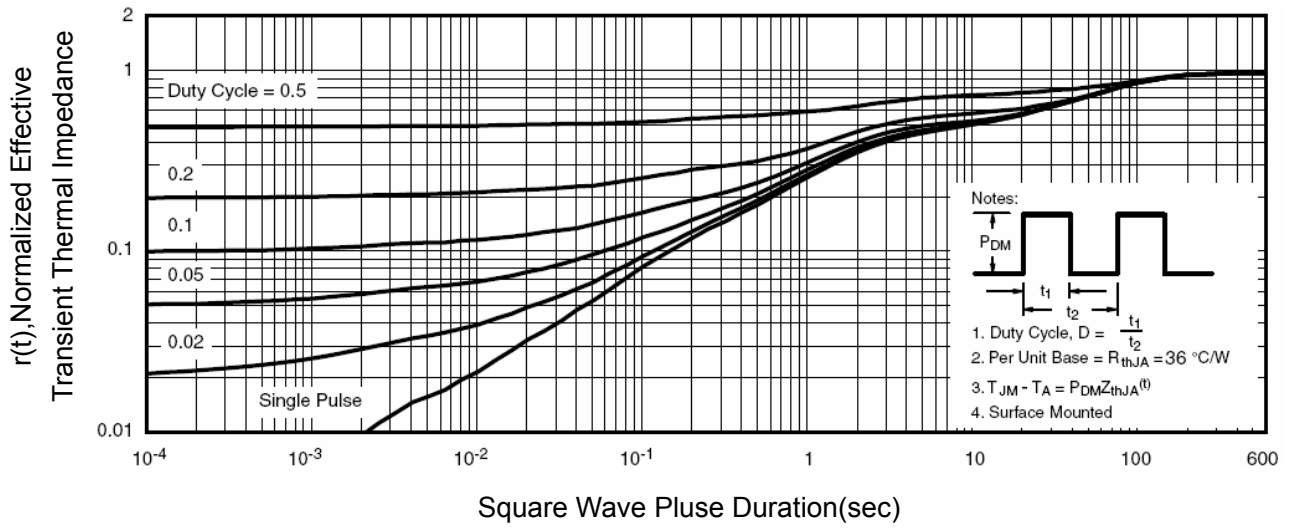
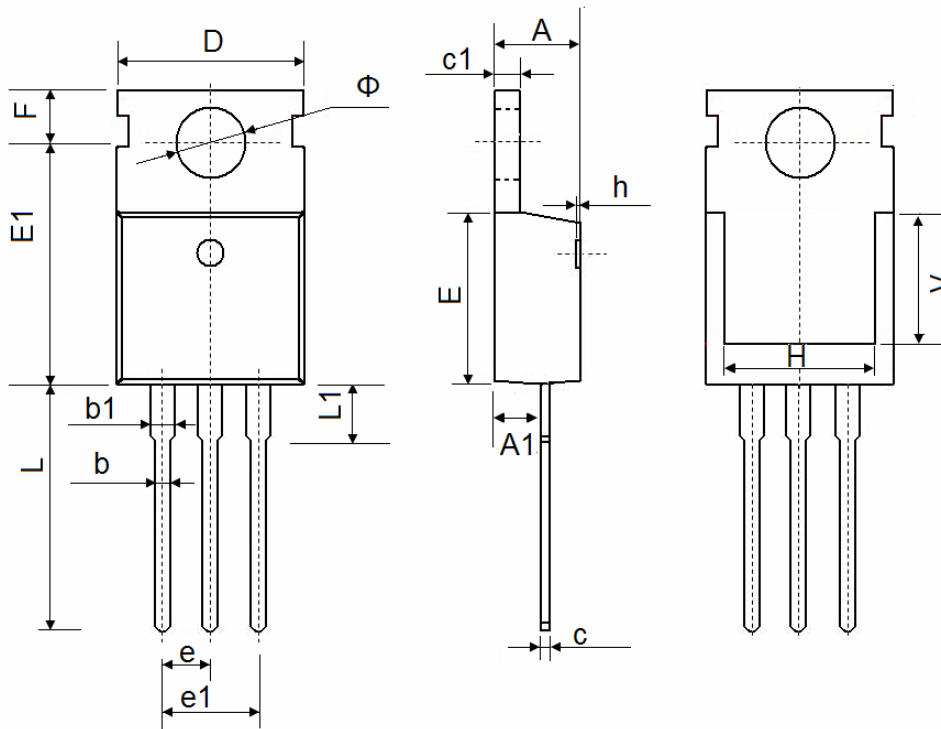

Figure 13 Normalized Maximum Transient Thermal Impedance

TO-220-3L Package Information



Symbol	Dimensions In Millimeters		Dimensions In Inches	
	Min.	Max.	Min.	Max.
A	4.400	4.600	0.173	0.181
A1	2.250	2.550	0.089	0.100
b	0.710	0.910	0.028	0.036
b1	1.170	1.370	0.046	0.054
c	0.330	0.650	0.013	0.026
c1	1.200	1.400	0.047	0.055
D	9.910	10.250	0.390	0.404
E	8.9500	9.750	0.352	0.384
E1	12.650	12.950	0.498	0.510
e	2.540 TYP.		0.100 TYP.	
e1	4.980	5.180	0.196	0.204
F	2.650	2.950	0.104	0.116
H	7.900	8.100	0.311	0.319
h	0.000	0.300	0.000	0.012
L	12.900	13.400	0.508	0.528
L1	2.850	3.250	0.112	0.128
V	7.500 REF.		0.295 REF.	
Φ	3.400	3.800	0.134	0.150