

### Description

The HM8N15K uses advanced trench technology and design to provide excellent  $R_{DS(ON)}$  with low gate charge. It can be used in a wide variety of applications.

### General Features

- $V_{DS} = 150V, I_D = 1A$   
 $R_{DS(ON)} < 60m\Omega @ V_{GS}=10V$  (Typ:70m $\Omega$ )
- High density cell design for ultra low  $R_{dson}$
- Fully characterized avalanche voltage and current
- Good stability and uniformity with high  $E_{AS}$
- Excellent package for good heat dissipation

### Application

- Boost converters
- LED backlighting
- Uninterruptible power supply

**100% UIS TESTED!**

**100%  $\Delta V_{ds}$  TESTED!**

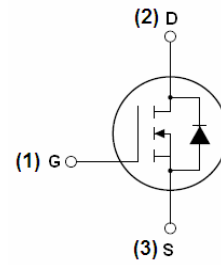

Schematic diagram

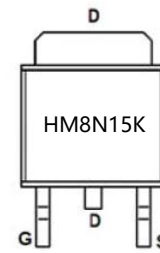

Marking and pin assignment

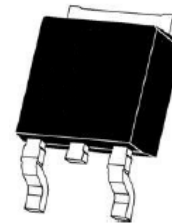

TO-252 -2Ltop view

### Package Marking and Ordering Information

Device Marking	Device	Device Package	Reel Size	Tape width	Quantity
HM8N15K	HM8N15K	TO-252-2L	-	-	-

### Absolute Maximum Ratings ( $T_C=25^\circ C$ unless otherwise noted)

Symbol	Parameter	Limit	Unit
$V_{DS}$	Drain-Source Voltage	150	V
$V_{GS}$	Gate-Source Voltage	$\pm 20$	V
$I_D$	Drain Current-Continuous	1A	A
$I_D(100^\circ C)$	Drain Current-Continuous( $T_C=100^\circ C$ )	1A	A
$I_{DM}$	Pulsed Drain Current	1A	A
$P_D$	Maximum Power Dissipation	75	W
	Derating factor	0.5	W/ $^\circ C$
$E_{AS}$	Single pulse avalanche energy <sup>(Note 5)</sup>	200	mJ
$T_J, T_{STG}$	Operating Junction and Storage Temperature Range	-55 To 175	$^\circ C$

### Thermal Characteristic

$R_{\theta JC}$	Thermal Resistance, Junction-to-Case <sup>(Note 2)</sup>	2.0	$^\circ C/W$
-----------------	--	-----	--------------

**Electrical Characteristics (T<sub>c</sub>=25°C unless otherwise noted)**

Symbol	Parameter	Condition	Min	Typ	Max	Unit
<b>Off Characteristics</b>						
BV <sub>DSS</sub>	Drain-Source Breakdown Voltage	V <sub>GS</sub> =0V, I <sub>D</sub> =250μA	150	165	-	V
I <sub>DSS</sub>	Zero Gate Voltage Drain Current	V <sub>DS</sub> =150V, V <sub>GS</sub> =0V	-	-	1	μA
I <sub>GSS</sub>	Gate-Body Leakage Current	V <sub>GS</sub> =±20V, V <sub>DS</sub> =0V	-	-	±100	nA
<b>On Characteristics (Note 3)</b>						
V <sub>GS(th)</sub>	Gate Threshold Voltage	V <sub>DS</sub> =V <sub>GS</sub> , I <sub>D</sub> =250μA	-	4.0	4.5	V
R <sub>DS(ON)</sub>	Drain-Source On-State Resistance	V <sub>GS</sub> =10V, I <sub>D</sub> =10A	-	6.0	6.5	mΩ
g <sub>FS</sub>	Forward Transconductance	V <sub>DS</sub> =5V, I <sub>D</sub> =10A	-	20	-	S
<b>Dynamic Characteristics (Note 4)</b>						
C <sub>iss</sub>	Input Capacitance	V <sub>DS</sub> =25V, V <sub>GS</sub> =0V, F=1.0MHz	-	2000	-	PF
C <sub>oss</sub>	Output Capacitance		-	290	-	PF
C <sub>rss</sub>	Reverse Transfer Capacitance		-	180	-	PF
<b>Switching Characteristics (Note 4)</b>						
t <sub>d(on)</sub>	Turn-on Delay Time	V <sub>DD</sub> =75V, R <sub>L</sub> =5Ω V <sub>GS</sub> =10V, R <sub>GEN</sub> =3Ω	-	10.5	-	nS
t <sub>r</sub>	Turn-on Rise Time		-	5.5	-	nS
t <sub>d(off)</sub>	Turn-Off Delay Time		-	14.5	-	nS
t <sub>f</sub>	Turn-Off Fall Time		-	3	-	nS
Q <sub>g</sub>	Total Gate Charge	V <sub>DS</sub> =75V, I <sub>D</sub> =10A, V <sub>GS</sub> =10V	-	17	-	nC
Q <sub>gs</sub>	Gate-Source Charge		-	4	-	nC
Q <sub>gd</sub>	Gate-Drain Charge		-	4.4	-	nC
<b>Drain-Source Diode Characteristics</b>						
V <sub>SD</sub>	Diode Forward Voltage (Note 3)	V <sub>GS</sub> =0V, I <sub>S</sub> =1 A	1.0	-	1.2	V
I <sub>S</sub>	Diode Forward Current (Note 2)	-	-	-	1.0	A
t <sub>rr</sub>	Reverse Recovery Time	T <sub>J</sub> = 25°C, I <sub>F</sub> = 10A	-	32	-	nS
Q <sub>rr</sub>	Reverse Recovery Charge	di/dt = 100A/μs (Note 3)	-	53	-	nC
t <sub>on</sub>	Forward Turn-On Time	Intrinsic turn-on time is negligible (turn-on is dominated by LS+LD)				

**Notes:**

1. Repetitive Rating: Pulse width limited by maximum junction temperature.
2. Surface Mounted on FR4 Board, t ≤ 10 sec.
3. Pulse Test: Pulse Width ≤ 300μs, Duty Cycle ≤ 2%.
4. Guaranteed by design, not subject to production
5. EAS condition: T<sub>J</sub>=25°C, V<sub>DD</sub>=50V, V<sub>G</sub>=10V, L=0.5mH, R<sub>g</sub>=25Ω

Test Circuit

1)  $E_{AS}$  Test Circuit

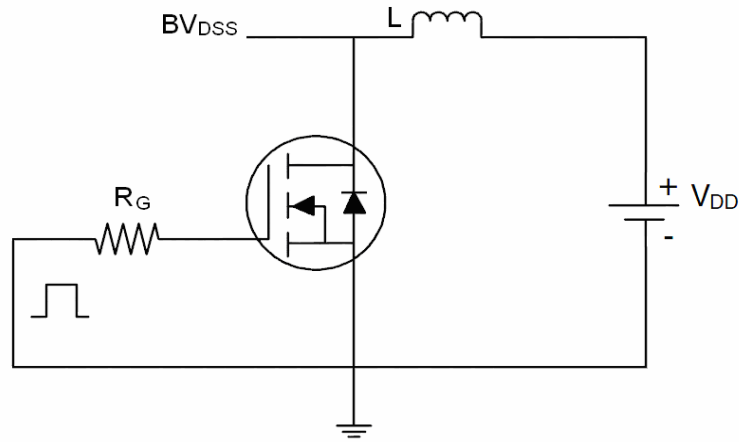

2) Gate Charge Test Circuit

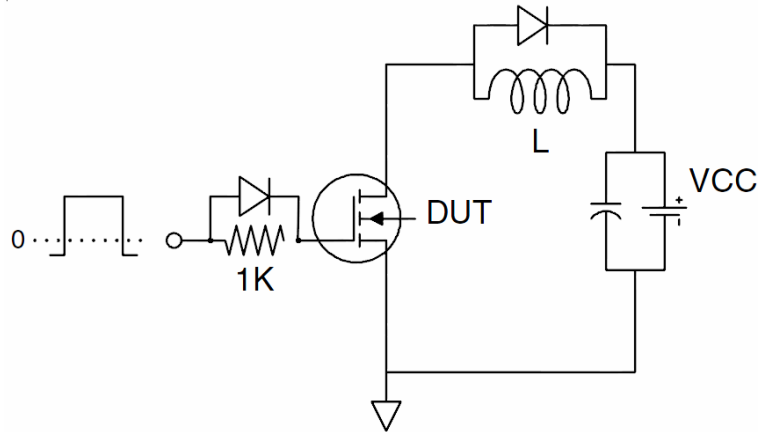

3) Switch Time Test Circuit

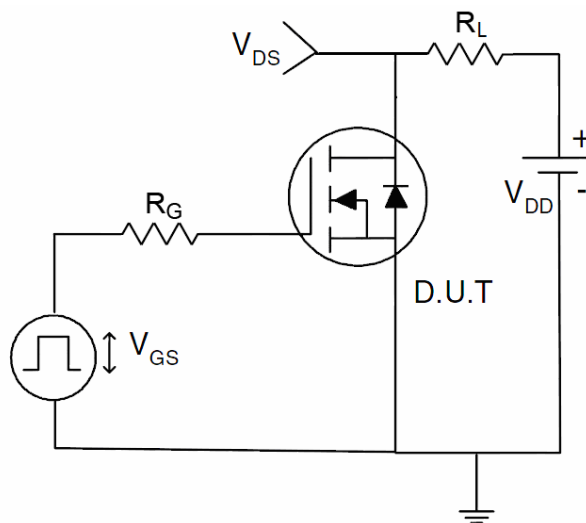

Typical Electrical and Thermal Characteristics (Curves)

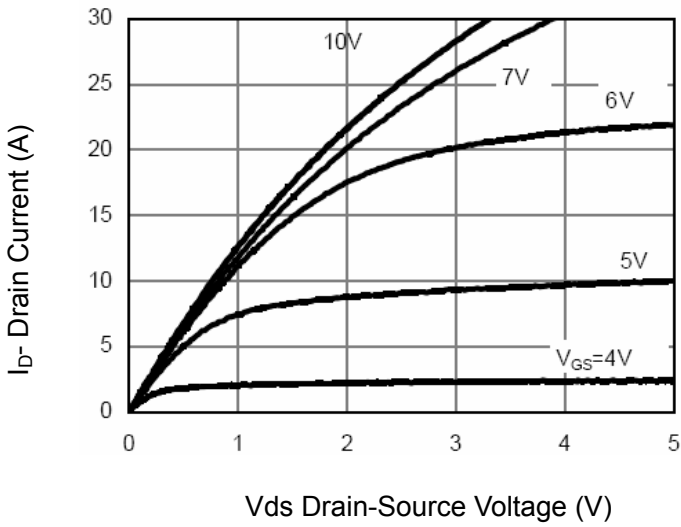

Figure 1 Output Characteristics

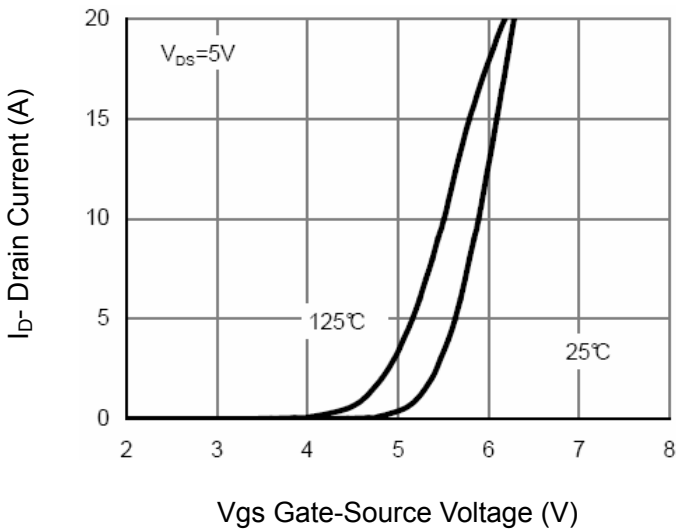

Figure 2 Transfer Characteristics

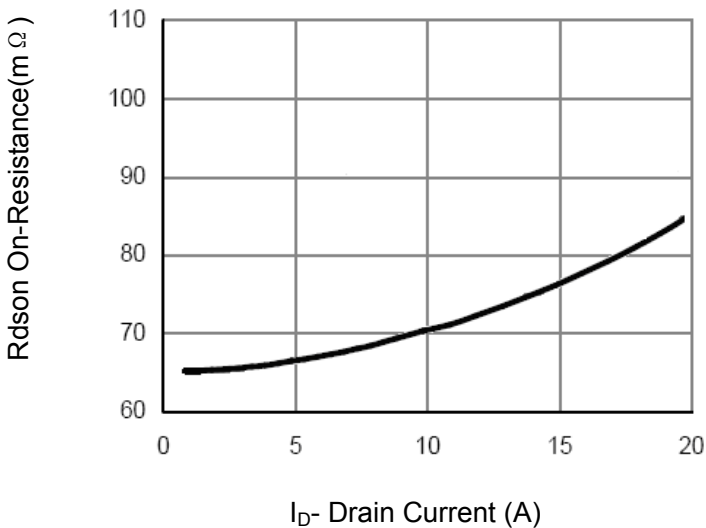

Figure 3 Rdson- Drain Current

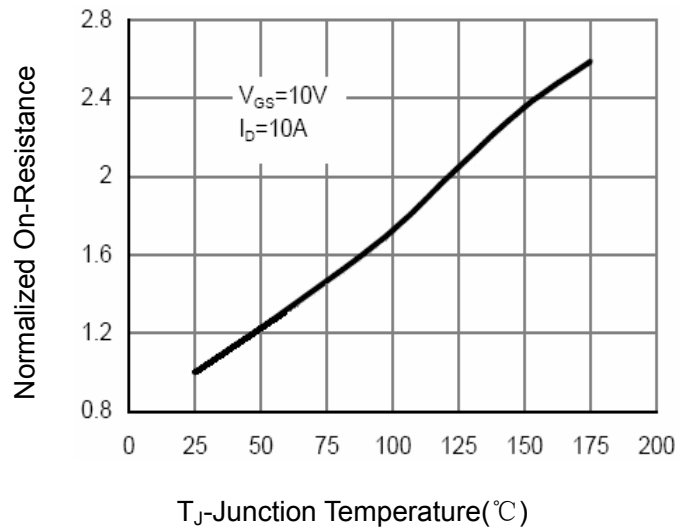

Figure 4 Rdson-Junction Temperature

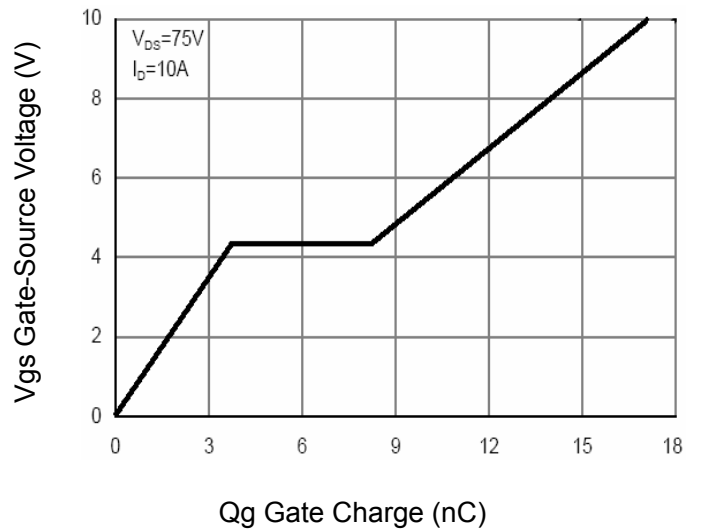

Figure 5 Gate Charge

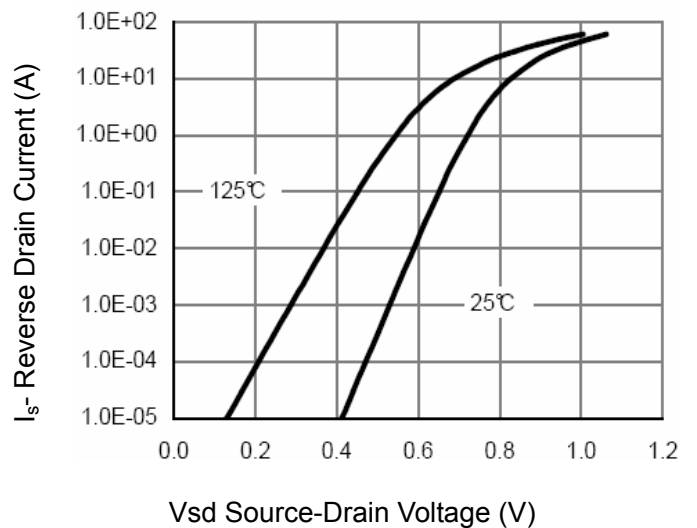

Figure 6 Source- Drain Diode Forward

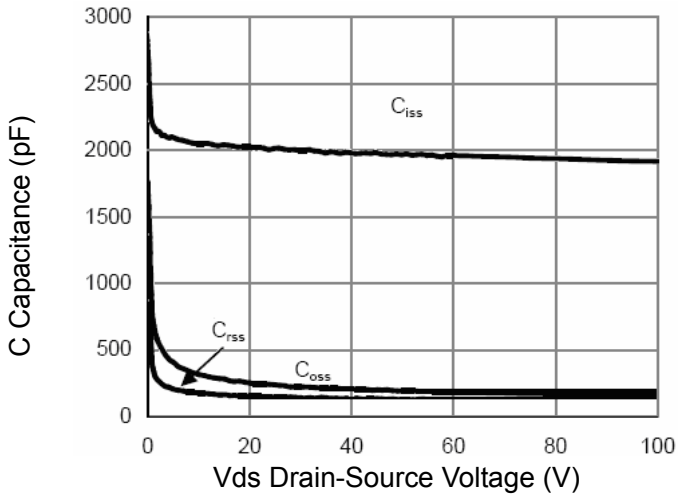

Figure 7 Capacitance vs Vds

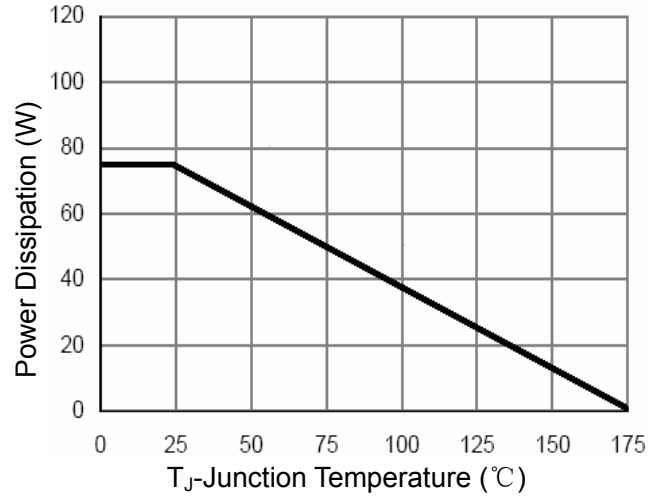

Figure 9 Power De-rating

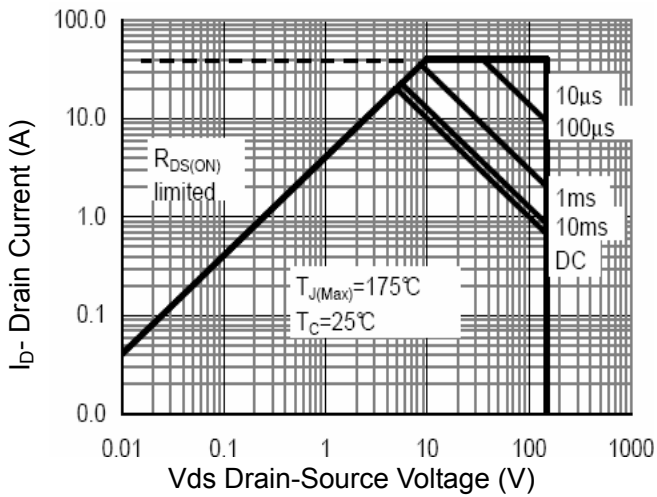

Figure 8 Safe Operation Area

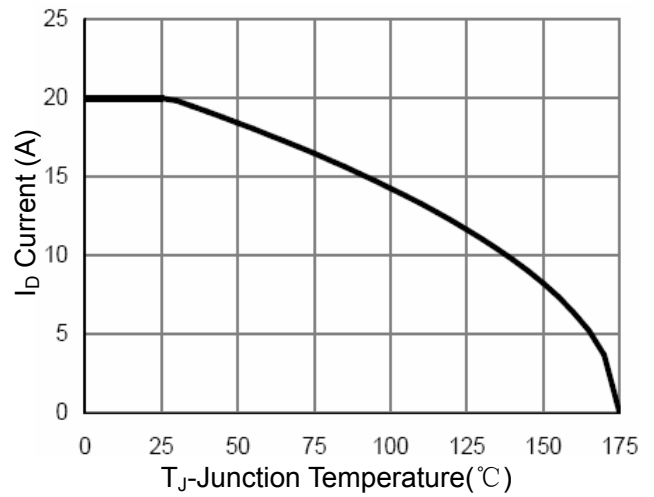

Figure 10 Id Current- Junction Temperature

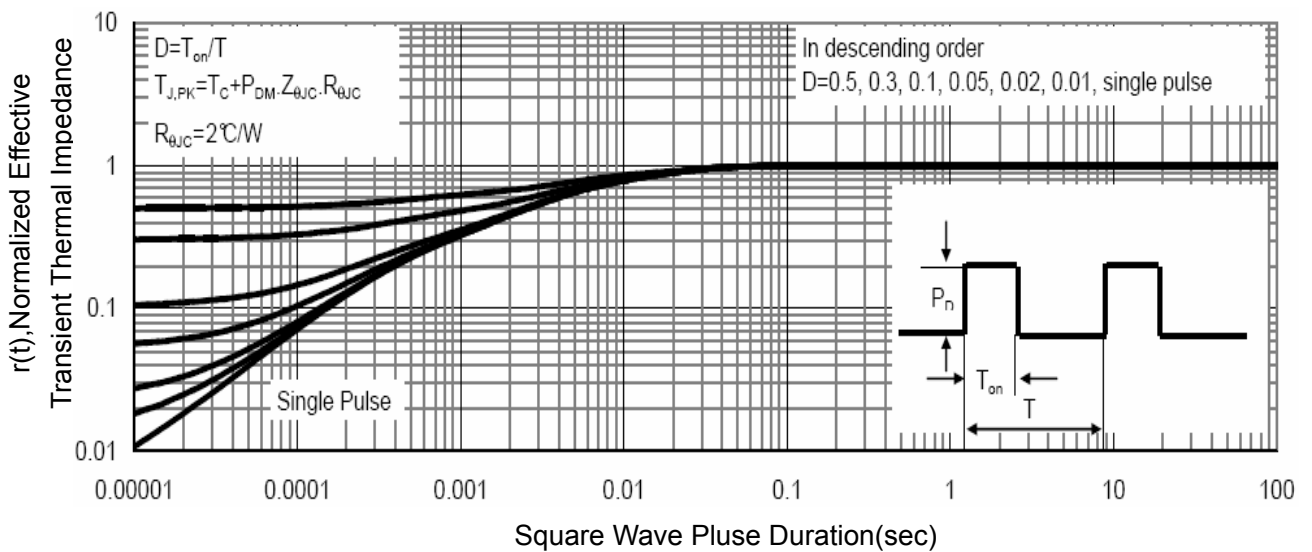
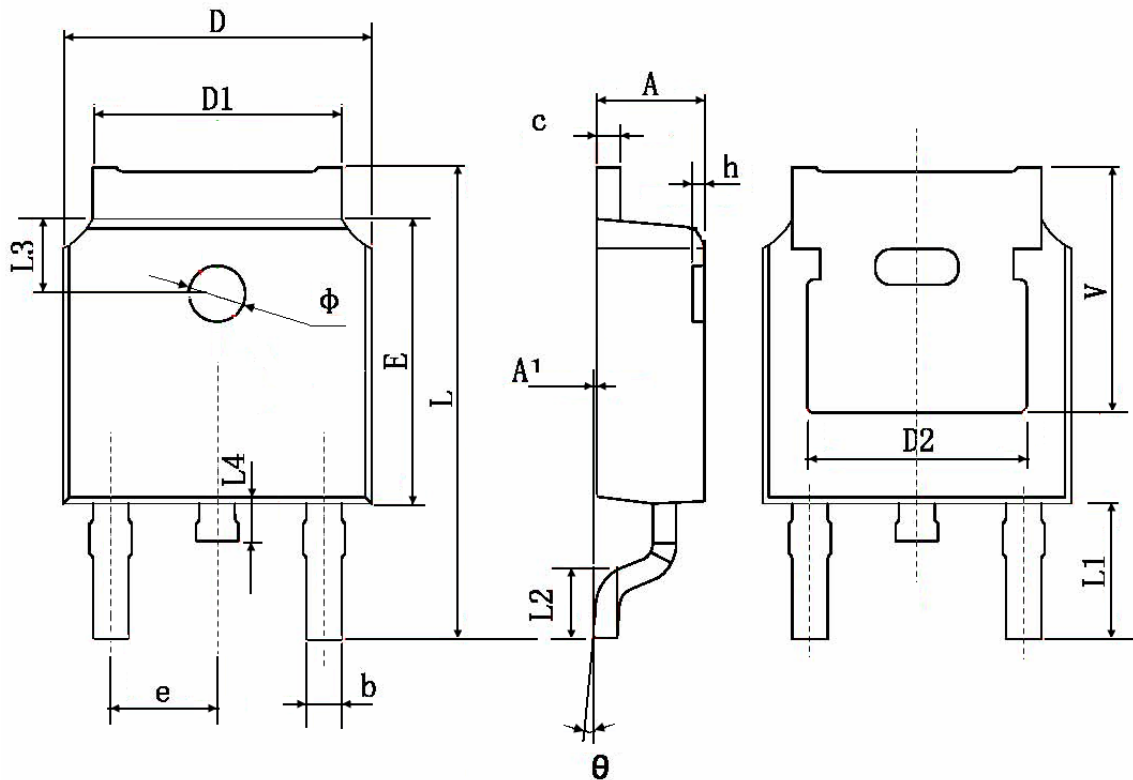

Figure 11 Normalized Maximum Transient Thermal Impedance

TO-252 Package Information



Symbol	Dimensions In Millimeters		Dimensions In Inches	
	Min.	Max.	Min.	Max.
A	2.200	2.400	0.087	0.094
A1	0.000	0.127	0.000	0.005
b	0.660	0.860	0.026	0.034
c	0.460	0.580	0.018	0.023
D	6.500	6.700	0.256	0.264
D1	5.100	5.460	0.201	0.215
D2	0.483 TYP.		0.190 TYP.	
E	6.000	6.200	0.236	0.244
e	2.186	2.386	0.086	0.094
L	9.800	10.400	0.386	0.409
L1	2.900 TYP.		0.114 TYP.	
L2	1.400	1.700	0.055	0.067
L3	1.600 TYP.		0.063 TYP.	
L4	0.600	1.000	0.024	0.039
Φ	1.100	1.300	0.043	0.051
θ	0°	8°	0°	8°
h	0.000	0.300	0.000	0.012
V	5.350 TYP.		0.211 TYP.	