

Dual N-Channel Enhancement Mode Power MOSFET

Description

The HM8205A uses advanced trench technology to provide excellent $R_{DS(ON)}$, low gate charge and operation with gate voltages as low as 2.5V. This device is suitable for use as a Battery protection or in other Switching application.

General Features

- $V_{DS} = 19.5V, I_D = 6A$
 $R_{DS(ON)} < 37m\Omega @ V_{GS}=2.5V$
 $R_{DS(ON)} < 27m\Omega @ V_{GS}=4.5V$
- High Power and current handling capability
- Lead free product is acquired
- Surface Mount Package

Application

- Battery protection
- Load switch
- Power management

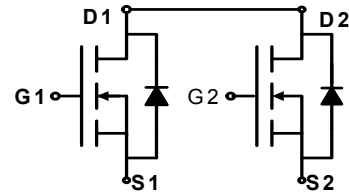

Schematic diagram

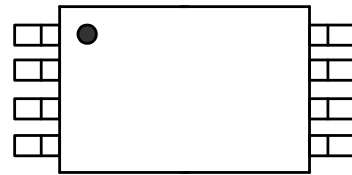

Marking and pin Assignment



TSSOP-8 top view

Package Marking And Ordering Information

Device Marking	Device	Device Package	Reel Size	Tape width	Quantity
8205A	HM8205A	TSSOP-8	Ø330mm	12mm	3000 units

Absolute Maximum Ratings (TA=25°C unless otherwise noted)

Parameter	Symbol	Limit	Unit
Drain-Source Voltage	V_{DS}	19.5	V
Gate-Source Voltage	V_{GS}	±10	V
Drain Current-Continuous	I_D	6	A
Drain Current-Pulsed (Note 1)	I_{DM}	25	A
Maximum Power Dissipation	P_D	1.5	W
Operating Junction and Storage Temperature Range	T_J, T_{STG}	-55 To 150	°C

Thermal Characteristic

Thermal Resistance, Junction-to-Ambient (Note 2)	$R_{\theta JA}$	83	°C/W
--	-----------------	----	------

Electrical Characteristics (TA=25°C unless otherwise noted)

Parameter	Symbol	Condition	Min	Typ	Max	Unit
Off Characteristics						
Drain-Source Breakdown Voltage	BV_{DSS}	$V_{GS}=0V, I_D=250\mu A$	19.5	21	-	V
Zero Gate Voltage Drain Current	I_{DSS}	$V_{DS}=19.5V, V_{GS}=0V$	-	-	1	μA

Gate-Body Leakage Current	I_{GSS}	$V_{GS}=\pm 10V, V_{DS}=0V$	-	-	± 100	nA
On Characteristics (Note 3)						
Gate Threshold Voltage	$V_{GS(th)}$	$V_{DS}=V_{GS}, I_D=250\mu A$	0.5	0.7	1.2	V
Drain-Source On-State Resistance	$R_{DS(ON)}$	$V_{GS}=4.5V, I_D=4.5A$	-	21	27	m Ω
		$V_{GS}=2.5V, I_D=3.5A$	-	27	37	m Ω
Forward Transconductance	g_{FS}	$V_{DS}=5V, I_D=4.5A$	-	10	-	S
Dynamic Characteristics (Note4)						
Input Capacitance	C_{iss}	$V_{DS}=8V, V_{GS}=0V,$ $F=1.0MHz$	-	600	-	PF
Output Capacitance	C_{oss}		-	330	-	PF
Reverse Transfer Capacitance	C_{rss}		-	140	-	PF
Switching Characteristics (Note 4)						
Turn-on Delay Time	$t_{d(on)}$	$V_{DD}=10V, I_D=1A$ $V_{GS}=4.5V, R_{GEN}=6\Omega$	-	10	20	nS
Turn-on Rise Time	t_r		-	11	25	nS
Turn-Off Delay Time	$t_{d(off)}$		-	35	70	nS
Turn-Off Fall Time	t_f		-	30	60	nS
Total Gate Charge	Q_g	$V_{DS}=10V, I_D=6A,$ $V_{GS}=4.5V$	-	10	15	nC
Gate-Source Charge	Q_{gs}		-	2.3	-	nC
Gate-Drain Charge	Q_{gd}		-	1.5	-	nC
Drain-Source Diode Characteristics						
Diode Forward Voltage (Note 3)	V_{SD}	$V_{GS}=0V, I_S=1.7A$	-	0.75	1.2	V
Diode Forward Current (Note 2)	I_S		-	-	1.7	A

Notes:

1. Repetitive Rating: Pulse width limited by maximum junction temperature.
2. Surface Mounted on FR4 Board, $t \leq 10$ sec.
3. Pulse Test: Pulse Width $\leq 300\mu s$, Duty Cycle $\leq 2\%$.
4. Guaranteed by design, not subject to production

TYPICAL ELECTRICAL AND THERMAL CHARACTERISTICS

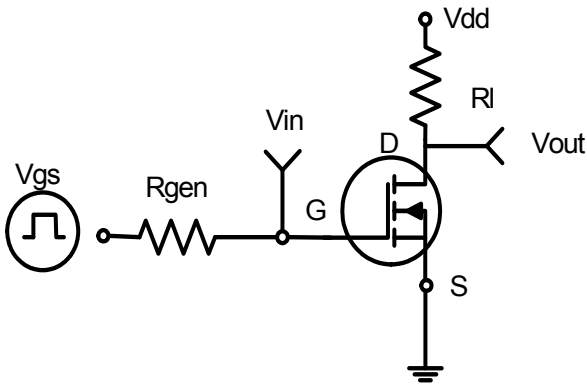

Figure 1: Switching Test Circuit

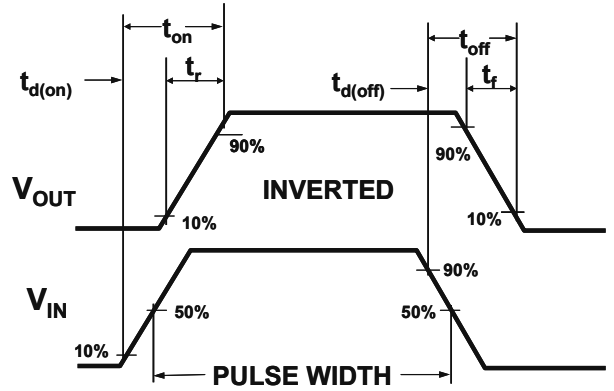

Figure 2: Switching Waveforms

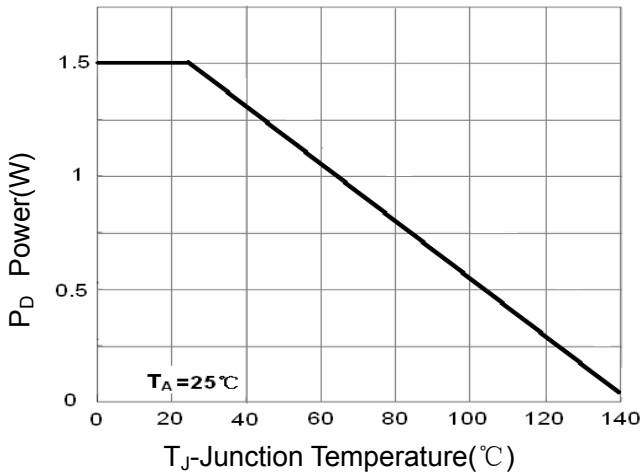

Figure 3 Power Dissipation

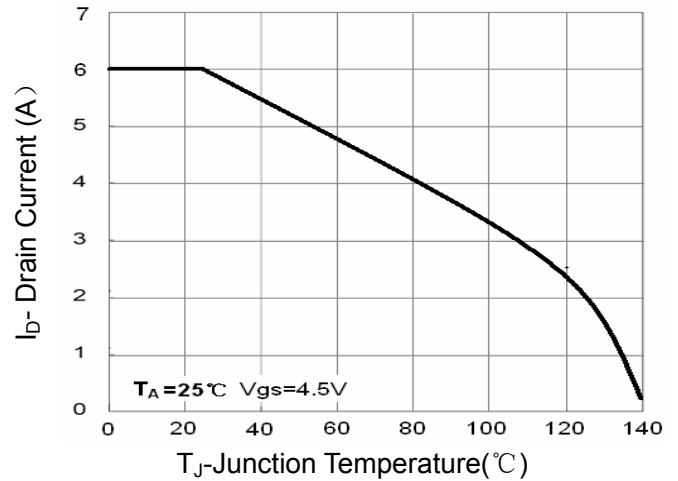

Figure 4 Drain Current

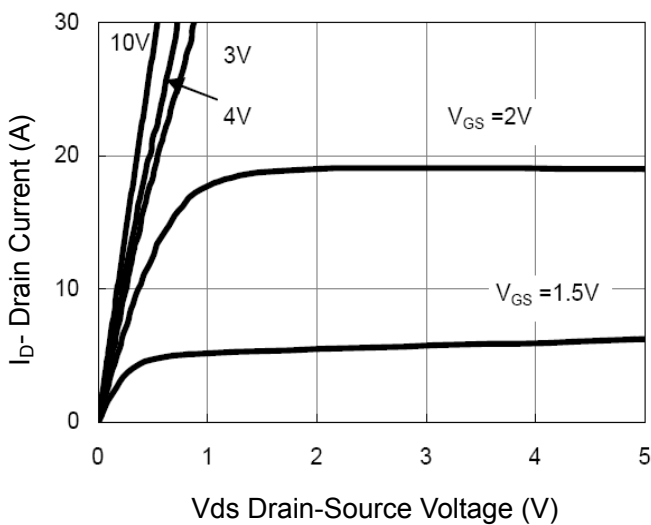

Figure 5 Output CHARACTERISTICS

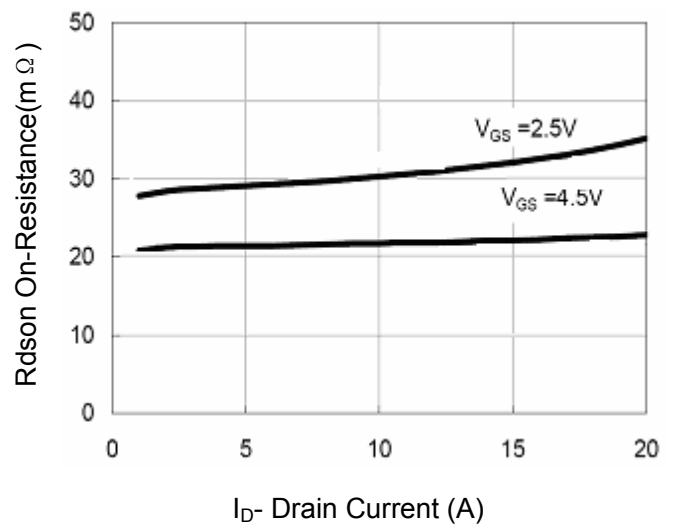

Figure 6 Drain-Source On-Resistance

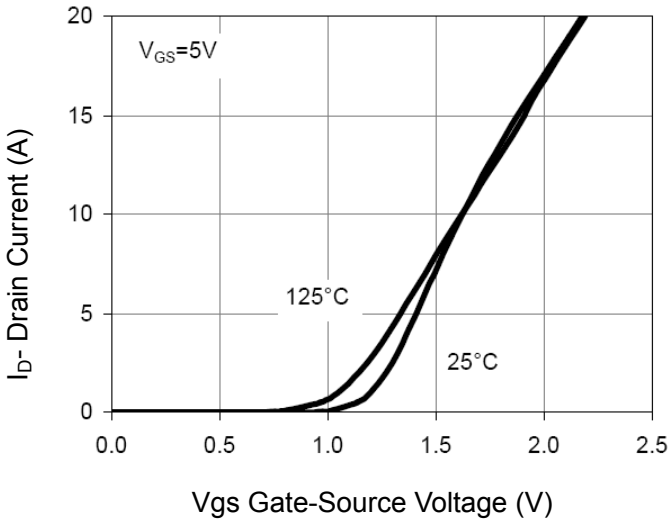

Figure 7 Transfer Characteristics

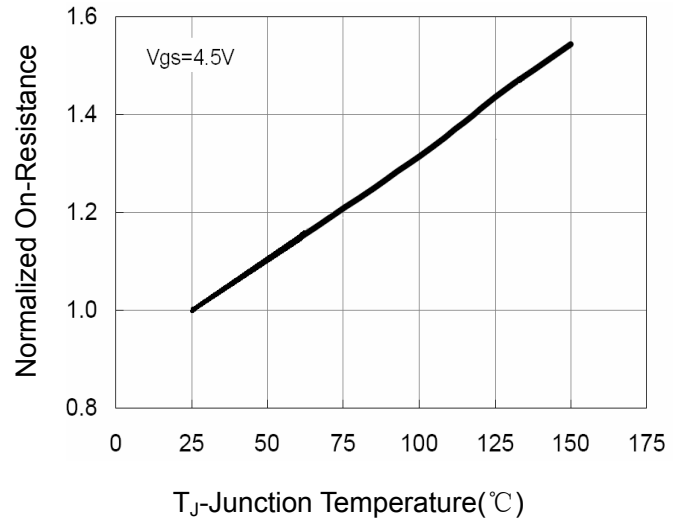

Figure 8 Drain-Source On-Resistance

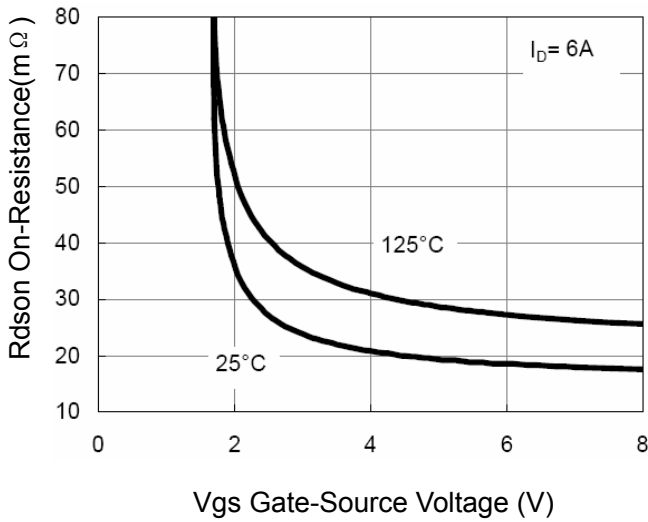

Figure 9 Rdson vs Vgs

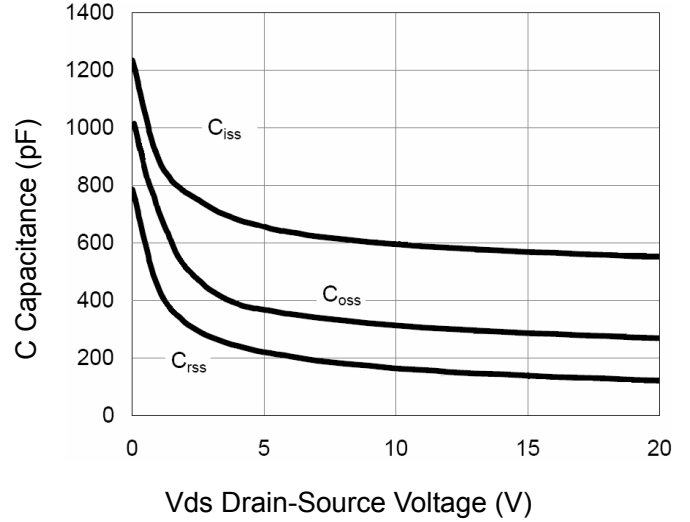

Figure 10 Capacitance vs Vds

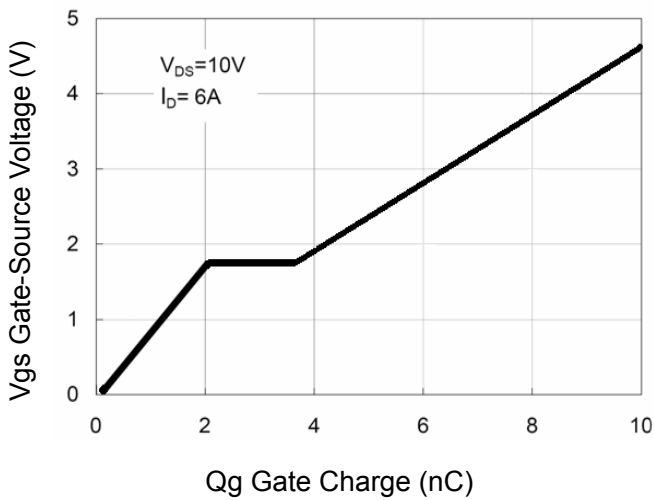

Figure 11 Gate Charge

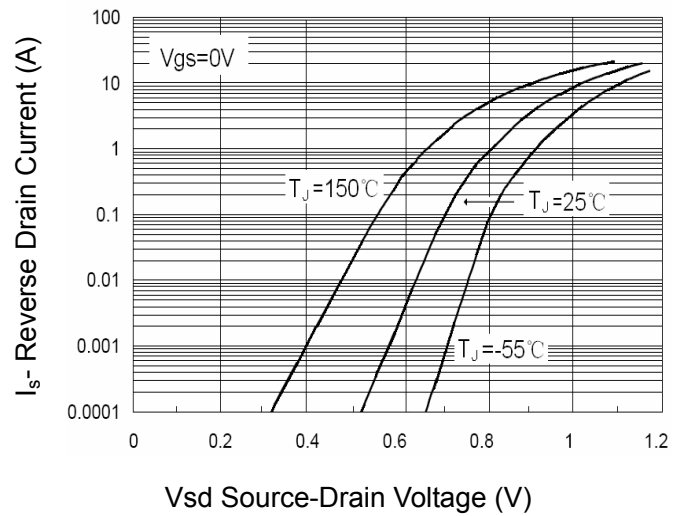

Figure 12 Source- Drain Diode Forward

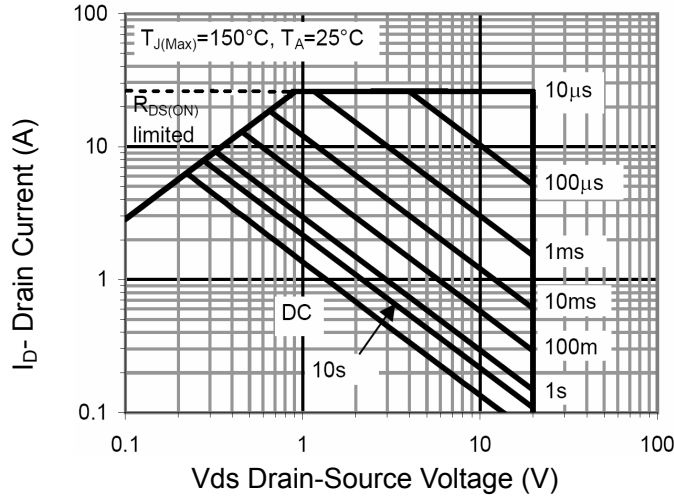

Figure 13 Safe Operation Area

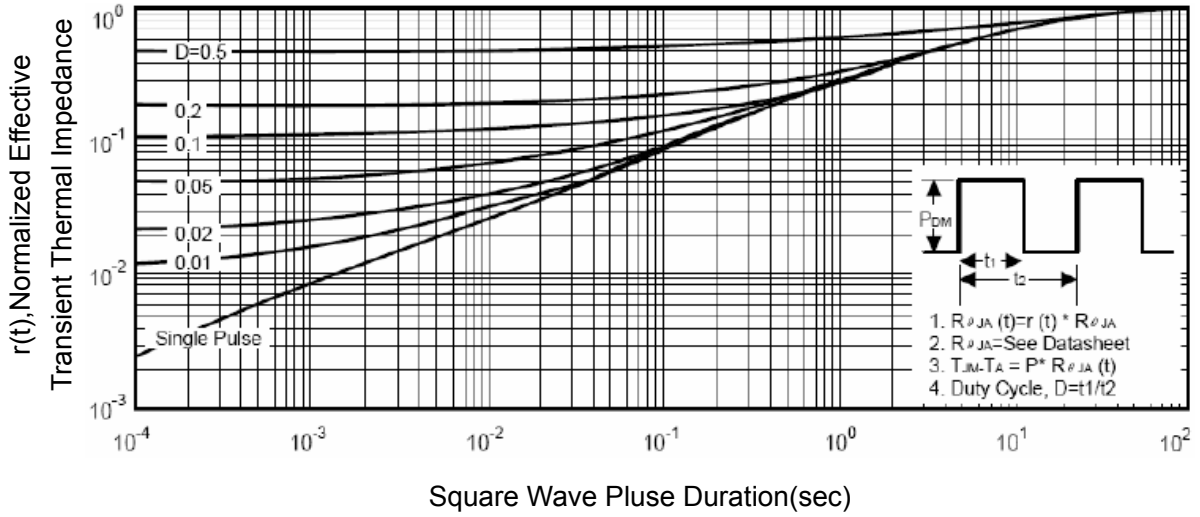
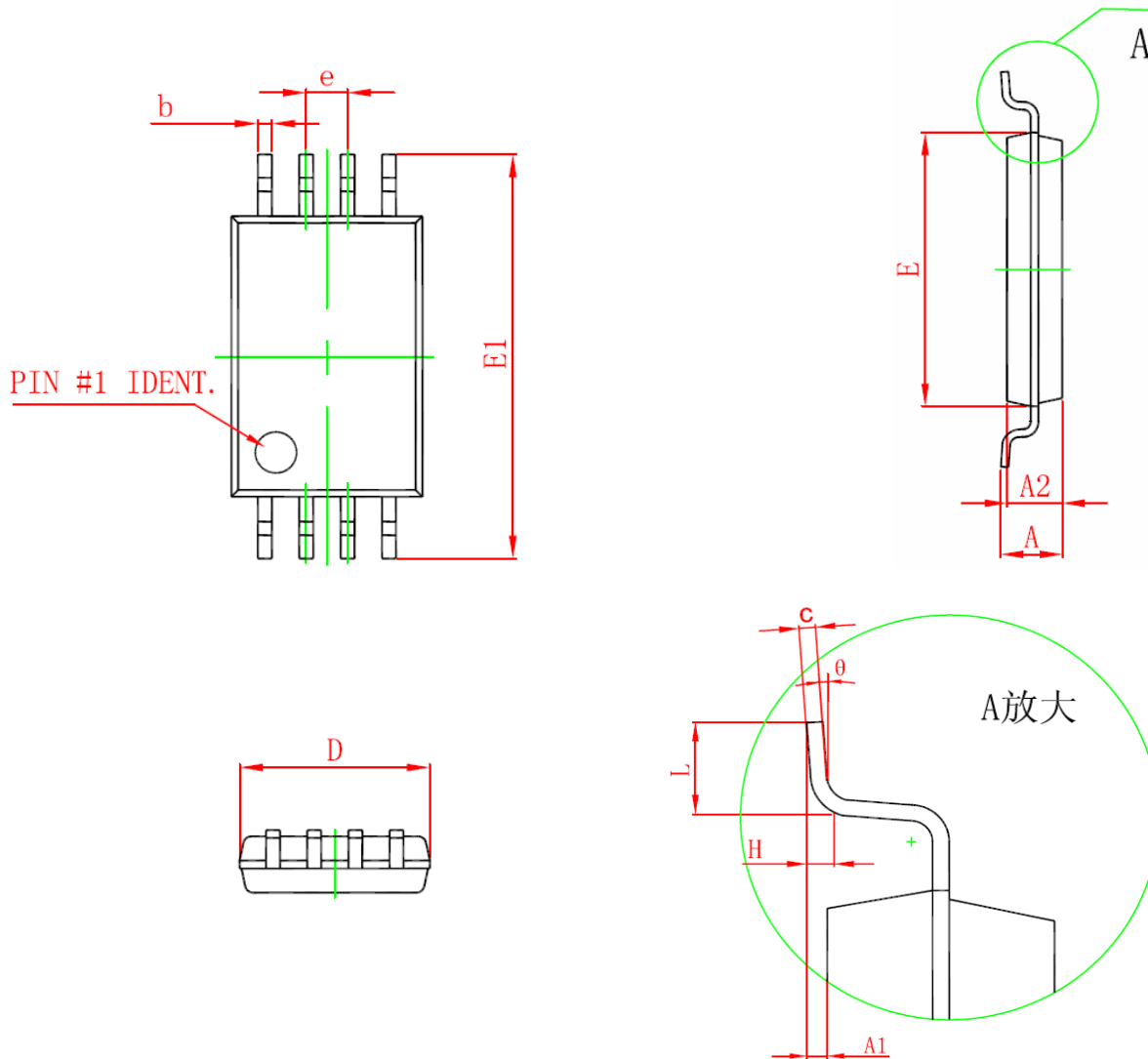

Figure 14 Normalized Maximum Transient Thermal Impedance

TSSOP-8 PACKAGE INFORMATION



Symbol	Dimensions In Millimeters	
	Min	Max
D	2.900	3.100
E	4.300	4.500
b	0.190	0.300
c	0.090	0.200
E1	6.250	6.550
A		1.100
A2	0.800	1.000
A1	0.020	0.150
e	0.65(BSC)	
L	0.500	0.700
H	0.25(TYP)	
θ	1°	7°