

N And P-Channel Enhancement Mode MOSFET

Description

The HM4622Q uses advanced trench technology to provide excellent $R_{DS(ON)}$ and low gate charge. The complementary MOSFETs may be used to form a level shifted high side switch, and for a host of other applications.

General Features

◆ N-channel:

$V_{DS} = 20V, I_D = 25A$

$R_{DS(ON)} = 8.2m\Omega$ (typical) @ $V_{GS} = 2.5V$

$R_{DS(ON)} = 6.2m\Omega$ (typical) @ $V_{GS} = 4.5V$

P-Channel:

$V_{DS} = -20V, I_D = -25A$

$R_{DS(ON)} = 17.5m\Omega$ (typical) @ $V_{GS} = -2.5V$

$R_{DS(ON)} = 13m\Omega$ (typical) @ $V_{GS} = -4.5V$

- ◆ Excellent gate charge x $R_{DS(ON)}$ product(FOM)
- ◆ Very low on-resistance $R_{DS(ON)}$
- ◆ 150 °C operating temperature
- ◆ Pb-free lead plating
- ◆ 100% UIS tested

100% UIS TESTED!

Application

100% ΔV_{ds} TESTED!

- ◆ Pch+Nch Complementary MOSFET for DC-FAN
- ◆ H-Bridge application

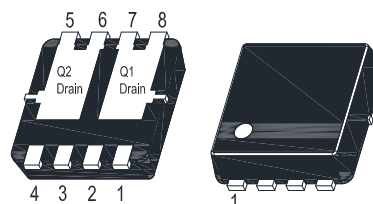

Q1:1.Source 2.Gate 7.Drain 8.Drain
Q2:3.Source 4.Gate 5.Drain 6.Drain
DFN3X3-8L Plastic Package

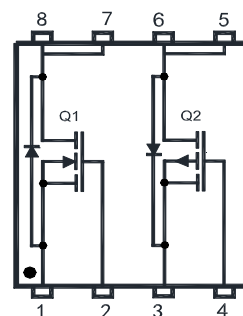

Ordering Information

Part Number	Storage Temperature	Package	Devices Per Reel
HM4622Q	-55°C to +150°C	DFN3X3-8L	5000

Absolute Maximum Ratings (TA=25°C unless otherwise noted)

Parameter	Symbol	Limit		Unit	
		N	P		
Drain-source voltage	V_{DS}	20	-20	V	
Gate-source voltage	V_{GS}	± 12	± 12	V	
Operating junction Temperature range	T_j	-55—150	-55—150	°C	
Drain Current-Continuous (Silicon Limited)	$T_A = 25^\circ C$	I_D	25	-25	A
	$T_A = 75^\circ C$		17.5	-17.5	

Pulsed Drain Current (Package Limited)		I_{DM}	75	-75	A
Avalanche Current ^C		I_{AS}, I_{AR}	22	-27	A
Avalanche energy $L=0.1mH^C$		E_{AS}, E_{AR}	24	36	mJ
Power Dissipation ^B	$T_A=25^\circ C$	P_D	12	20	W
	$T_A=75^\circ C$		5	8	
Junction and Storage Temperature Range		T_J, T_{STG}	-55—150		$^\circ C$

N-Channel Electrical Characteristics ($T_J=25^\circ C$ unless otherwise noted)

Parameter	Symbol	Condition	Min	Typ	Max	Unit
OFF Characteristics						
Drain-source breakdown voltage	BV_{DSS}	$V_{GS}=0V, I_D=250\mu A$	20	-	-	V
Zero gate voltage drain current	I_{DSS}	$V_{DS}=20V, V_{GS}=0V$	-	-	1	μA
Gate-body leakage	I_{GSS}	$V_{DS}=0V, V_{GS}=\pm 20V$	-	-	± 100	nA
ON Characteristics						
Gate threshold voltage	$V_{GS(th)}$	$V_{DS}=V_{GS}, I_D=250\mu A$	0.5	0.75	1.0	V
Drain-source on-state resistance	$R_{DS(on)}$	$V_{GS}=2.5V, I_D=25A$	-	8.2	10.7	m Ω
		$V_{GS}=4.5V, I_D=25A$	-	6.2	8.1	
Forward transconductance	gfs	$V_{DS}=5V, I_D=20A$	-	43	-	S
Dynamic Characteristics						
Input capacitance	C_{ISS}	$V_{DS}=15V, V_{GS}=0V$ $f=1.0MHz$	-	985	-	pF
Output capacitance	C_{OSS}		-	132	-	
Reverse transfer capacitance	C_{RSS}		-	114	-	
Gate resistance	R_g	$V_{GS}=0V, V_{DS}=0V,$ $f=1.0MHz$	-	1.6	2.4	Ω
Switching Characteristics						
Turn-on delay time	$t_{D(on)}$	$V_{DS}=15V$ $V_{GS}=10V$ $R_L=1.5\Omega$ $R_{GEN}=3\Omega$	-	4.4	-	ns
Rise time	t_r		-	9	-	
Turn-off delay time	$t_{D(off)}$		-	17	-	
Fall time	t_f		-	6	-	
Total gate charge	Qg	$V_{DS}=15V, I_D=25A$ $V_{GS}=10V$	-	19.9	-	nC
Gate-source charge	Qgs		-	3.7	-	
Gate-drain charge	Qgd		-	4	-	

Typical Performance Characteristics

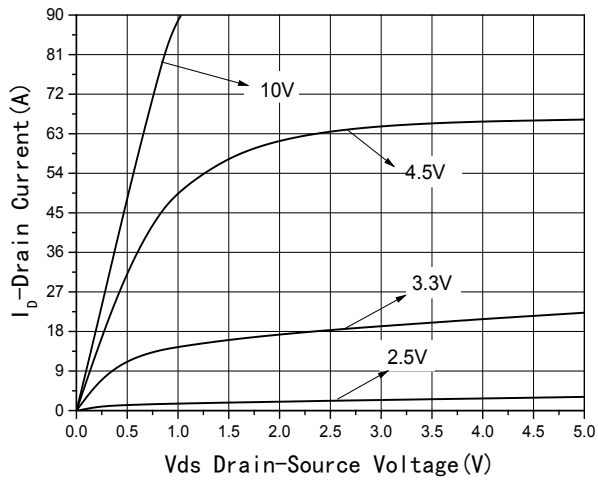

Fig1 Output Characteristics

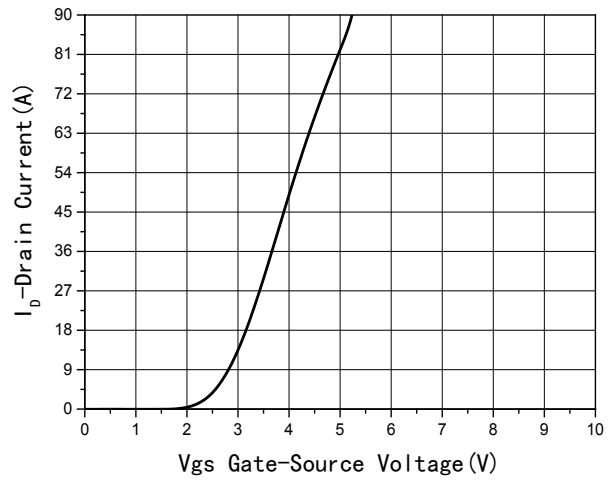

Fig2 Transfer Characteristics

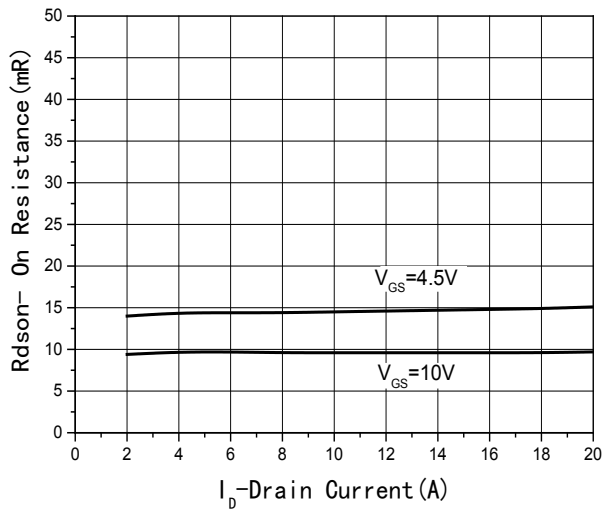

Fig3 Rdson-Drain current

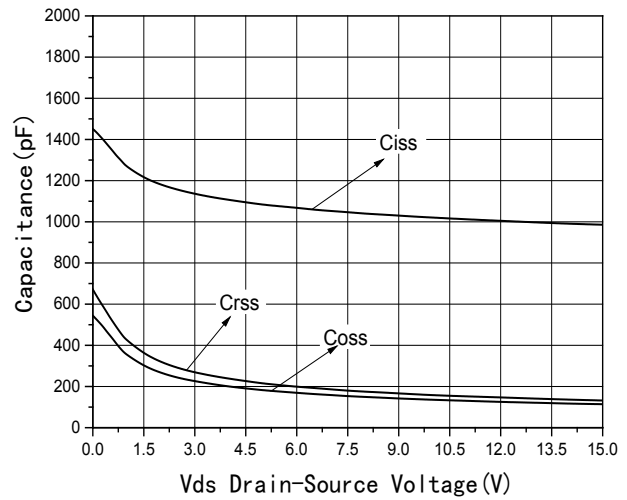

Fig4 Capacitance vs Vds

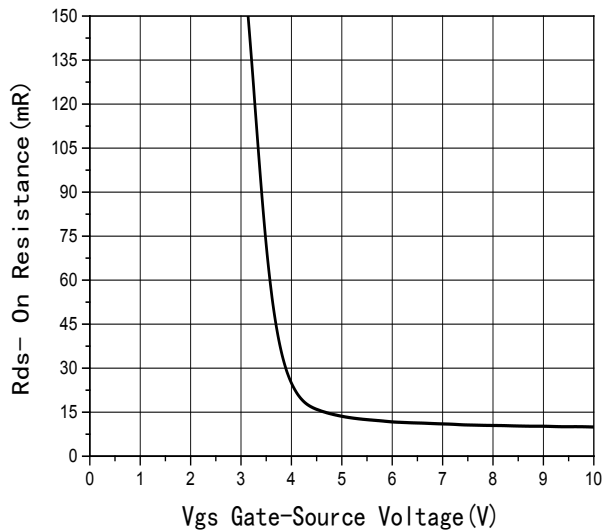

Fig5 Rdson-Gate Drain voltage

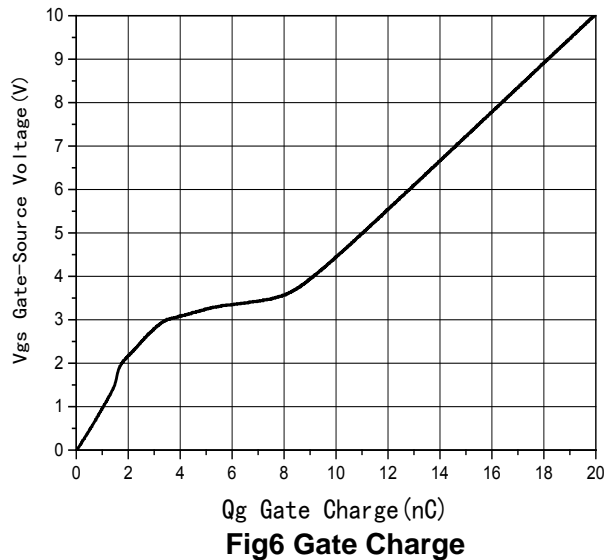

Fig6 Gate Charge

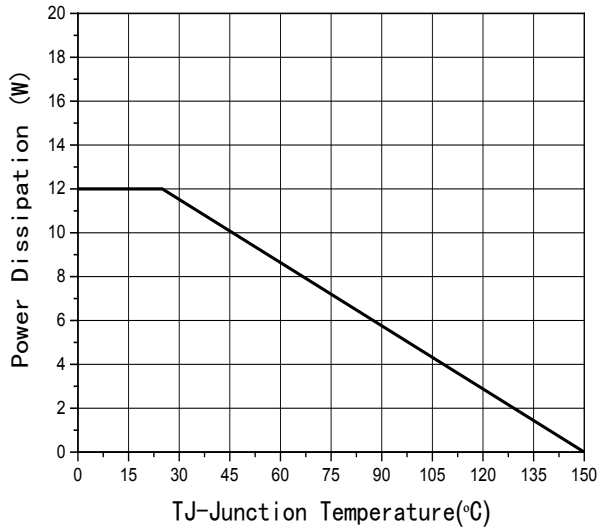

Fig7 Power De-rating

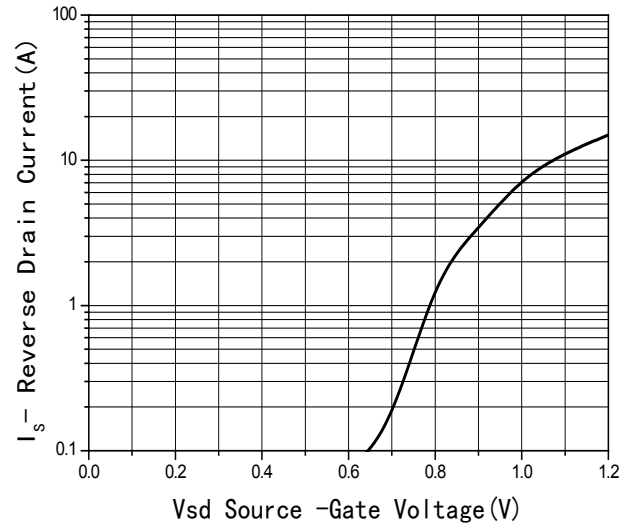

Fig8 Source-Drain Diode Forward

P-Channel Electrical Characteristics (T_J=25°C unless otherwise noted)

Parameter	Symbol	Condition	Min	Typ	Max	Unit
OFF Characteristics						
Drain-source breakdown voltage	BV _{DSS}	V _{GS} =0V, I _D =-250μA	-20	-	-	V
Zero gate voltage drain current	I _{DSS}	V _{DS} =-20V, V _{GS} =0V	-	-	-1	μA
Gate-body leakage	I _{GSS}	V _{DS} =0V, V _{GS} =±20V	-	-	±100	nA
ON Characteristics						
Gate threshold voltage	V _{GS(th)}	V _{DS} =V _{GS} , I _D =-250μA	-0.5	-0.75	-1.0	V
Drain-source on-state resistance	R _{DS(ON)}	V _{GS} =-2.5V, I _D =-20A	-	17.5	20	mΩ
		V _{GS} =-4.5V, I _D =-20A	-	13	15	
Forward transconductance	g _{fs}	V _{DS} =-5V, I _D =-10A	-	18	-	S
Dynamic Characteristics						
Input capacitance	C _{ISS}	V _{DS} =-15V, V _{GS} =0V f=1.0MHz	-	24	-	pF
Output capacitance	C _{OSS}		-	4.6	-	
Reverse transfer capacitance	C _{RSS}		-	4.2	-	
Gate resistance	R _g	V _{GS} =0V, V _{DS} =0V, f=1.0MHz	-	4	-	Ω
Switching Characteristics						
Turn-on delay time	t _{D(ON)}	V _{DS} =-15V V _{GS} =-10V R _L =2.3Ω R _{GEN} =3Ω	-	10	-	ns
Rise time	t _r		-	5.5	-	
Turn-off delay time	t _{D(OFF)}		-	3.6	-	
Fall time	t _f		-	4.6	-	
Total gate charge	Q _g	V _{DS} =-15V, I _D =-20A V _{GS} =-10V	-	1261	-	nC
Gate-source charge	Q _{gs}		-	152	-	
Gate-drain charge	Q _{gd}		-	137	-	

Typical Performance Characteristics

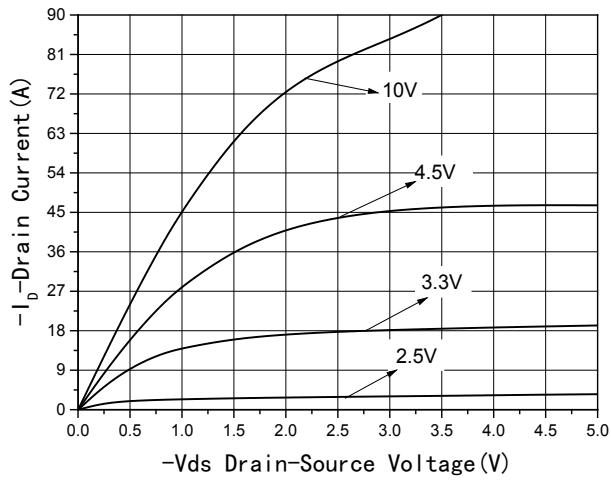

Fig1 Output Characteristics

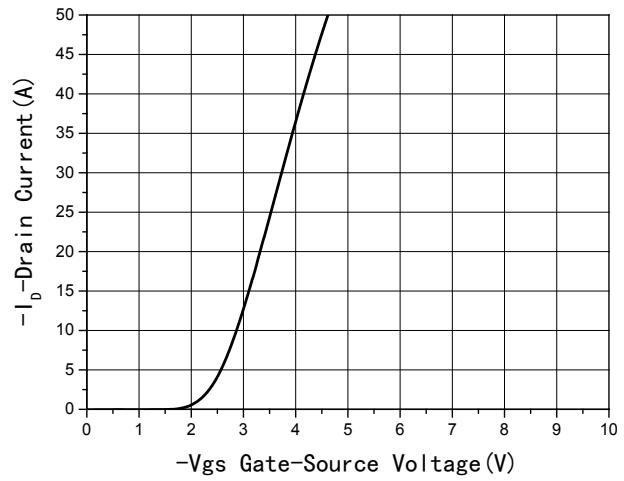

Fig2 Transfer Characteristics

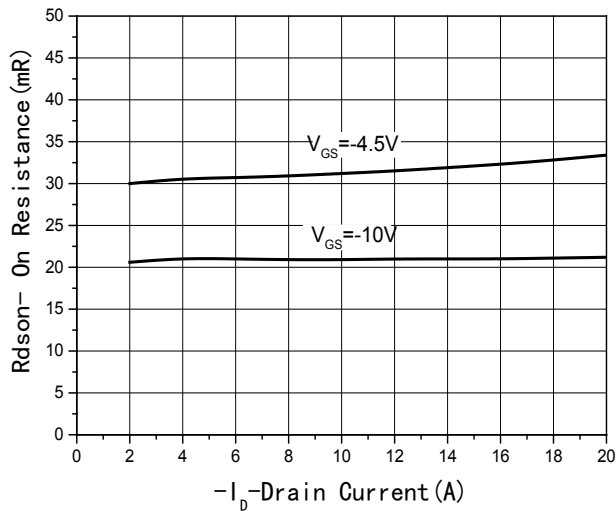

Fig3 $R_{ds(on)}$ -Drain current

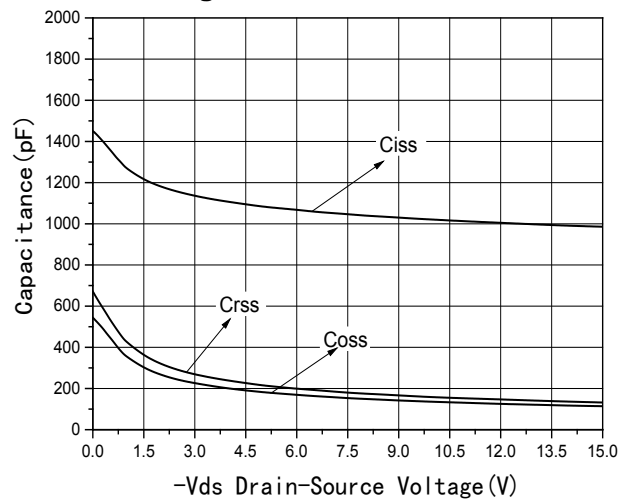

Fig4 Capacitance vs V_{DS}

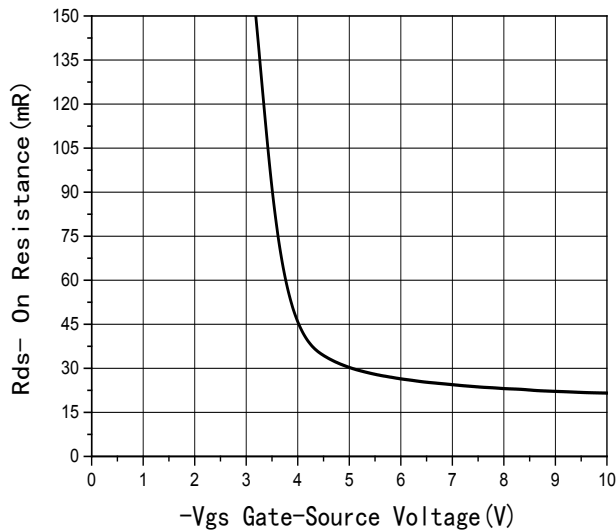

Fig5 $R_{ds(on)}$ -Gate Drain voltage

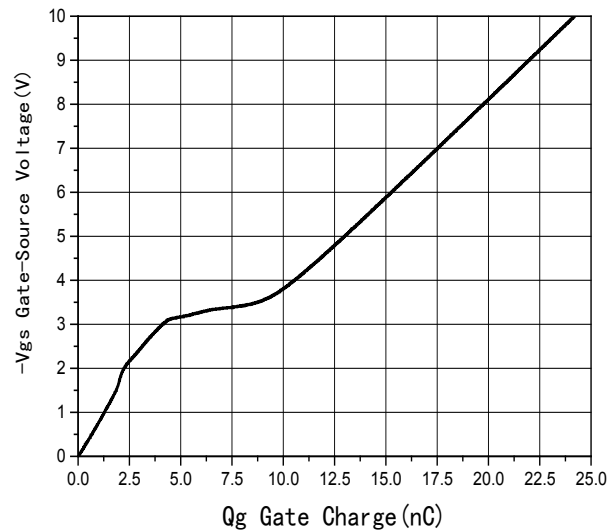

Fig6 Gate Charge

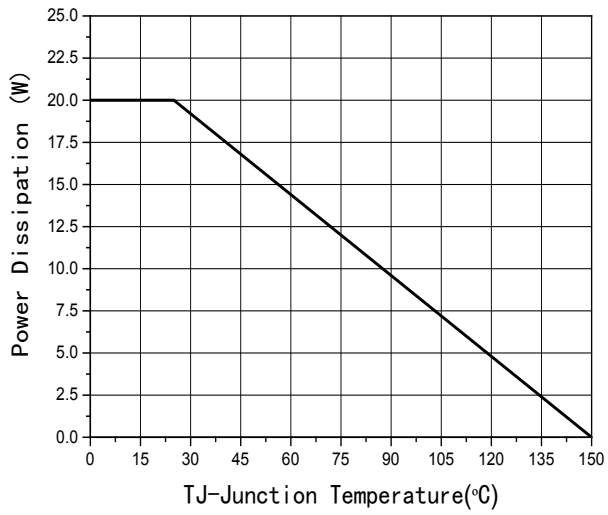

Fig7 Power De-rating

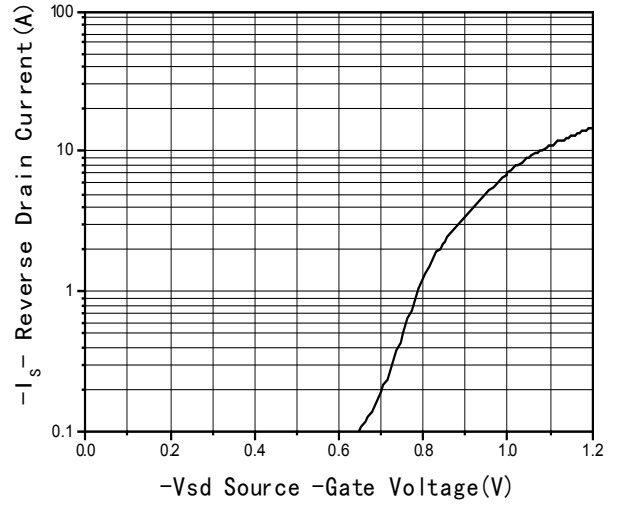
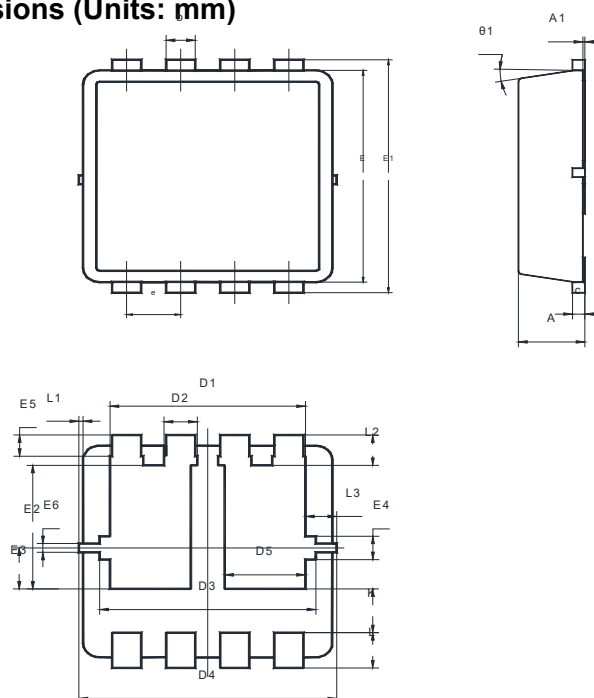

Fig8 Source-Drain Diode Forward

Package Outline Dimensions (Units: mm)

8: B' L' I, @



UNIT	A	A1	b	c	D1	D2	D3	D4	D5	E	E1	E2	E3
mm	0.9	0.05	0.35	0.25	2.6	0.5	2.7	3.2	1.135	3.1	3.3	1.85	0.68
	0.7	0	0.24	0.1	2.4	0.3	2.5	3	0.935	2.9	3.1	1.65	0.48

UNIT	E4	E5	E6	e	K	L	L1	L2	L3	θ1
mm	0.43	0.4	0.25	0.7	0.72	0.5	0.1	0.53	0.475	12°
	0.23	0.2	0.15	0.6	0.52	0.3	0	0.33	0.275	0°

Recommended Soldering Footprint

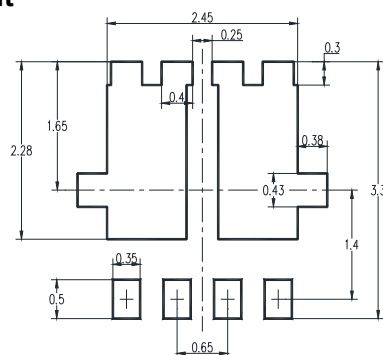

Packing information

Package	Tape Width (mm)	Pitch		Reel Size		Per Reel Packing Quantity
		mm	inch	mm	inch	
DFN3X3-8L	12	8 ± 0.1	0.315 ± 0.004	330	13	3,000