

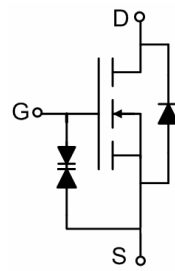
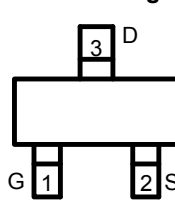

N-Channel Enhancement Mode Power MOSFET

<p>General Features</p> <ul style="list-style-type: none"> ● $V_{DS} = 60V, I_D = 0.5A$ ● $R_{DS(ON)} < 3\Omega @ V_{GS}=5V$ ● $R_{DS(ON)} < 2\Omega @ V_{GS}=10V$ ● ESD Rating: HBM 2300V ● High power and current handling capability ● Lead free product is acquired ● Surface mount package <p>Application</p> <ul style="list-style-type: none"> ● Direct logic-level interface: TTL/CMOS ● Drivers: relays, solenoids, lamps, hammers, display, memories, transistors, etc. ● Battery operated systems ● Solid-state relays 	<div style="text-align: center;">  <p>Schematic diagram</p> </div> <div style="text-align: center;">  <p>Marking and pin Assignment</p> </div> <div style="text-align: center;">  <p>SOT-323 top view</p> </div>
---	--

Package Marking And Ordering Information

Device Marking	Device	Device Package	Reel Size	Tape width	Quantity
7002KR	HM7002KR	SOT-23G	Ø180mm	8 mm	3000 units

Absolute Maximum Ratings ($T_A=25^\circ C$ unless otherwise noted)

Parameter	Symbol	Limit	Unit
Drain-Source Voltage	V_{DS}	60	V
Gate-Source Voltage	V_{GS}	± 20	V
Continuous Drain Current ($T_J = 150^\circ C$)	I_D	$T_A = 25^\circ C$	0.5
		$T_A = 100^\circ C$	0.3
Drain Current-Pulsed (Note 1)	I_{DM}	1.3	A
Maximum Power Dissipation	P_D	0.5	W
Operating Junction and Storage Temperature Range	T_J, T_{STG}	-55 To 150	$^\circ C$

Thermal Characteristic

Thermal Resistance, Junction-to-Ambient (Note 2)	$R_{\theta JA}$	350	$^\circ C/W$
--	-----------------	-----	--------------

Electrical Characteristics (T_A=25°C unless otherwise noted)

Parameter	Symbol	Condition	Min	Typ	Max	Unit
Off Characteristics						
Drain-Source Breakdown Voltage	BV _{DSS}	V _{GS} =0V, I _D =250μA	60	68	-	V
Zero Gate Voltage Drain Current	I _{DSS}	V _{DS} =60V, V _{GS} =0V	-	-	1	μA
Gate-Body Leakage Current	I _{GSS}	V _{GS} =±10V, V _{DS} =0V	-	±100	±500	nA
		V _{GS} =±20V, V _{DS} =0V	-	±4	±10	uA
On Characteristics (Note 3)						
Gate Threshold Voltage	V _{GS(th)}	V _{DS} =V _{GS} , I _D =250μA	0.8	-	2.5	V
Drain-Source On-State Resistance	R _{DS(ON)}	V _{GS} =5V, I _D =0.4A	-	-	3	Ω
		V _{GS} =10V, I _D =0.5A	-	-	2	Ω
Forward Transconductance	g _{FS}	V _{DS} =10V, I _D =0.2A	0.1	-	-	S
Dynamic Characteristics (Note4)						
Input Capacitance	C _{iss}	V _{DS} =25V, V _{GS} =0V, F=1.0MHZ	-	21	50	PF
Output Capacitance	C _{oss}		-	11	25	PF
Reverse Transfer Capacitance	C _{rss}		-	4.2	5	PF
Switching Characteristics (Note 4)						
Turn-on Delay Time	t _{d(on)}	V _{DD} =30V, I _D =0.2A V _{GS} =10V, R _{GEN} =10Ω	-	10	-	nS
Turn-on Rise Time	t _r		-	50	-	nS
Turn-Off Delay Time	t _{d(off)}		-	17	-	nS
Turn-Off Fall Time	t _f		-	10	-	nS
Total Gate Charge	Q _g	V _{DS} =10V, I _D =0.3A, V _{GS} =4.5V	-	1.7	3	nC
Drain-Source Diode Characteristics						
Diode Forward Voltage (Note 3)	V _{SD}	V _{GS} =0V, I _S =0.2A	-	-	1.3	V
Diode Forward Current (Note 2)	I _S		-	-	0.2	A

Notes:

1. Repetitive Rating: Pulse width limited by maximum junction temperature.
2. Surface Mounted on FR4 Board, t ≤ 10 sec.
3. Pulse Test: Pulse Width ≤ 300μs, Duty Cycle ≤ 2%.
4. Guaranteed by design, not subject to production

Typical Electrical And Thermal Characteristics

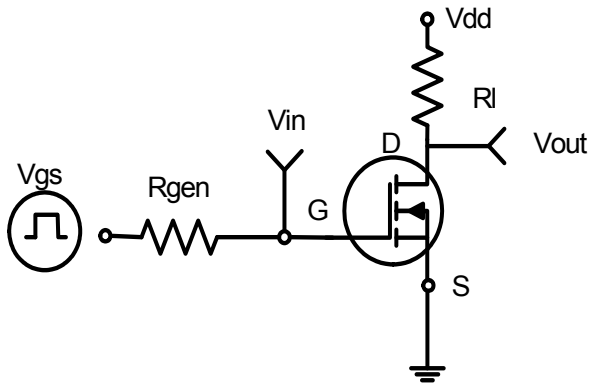

Figure 1: Switching Test Circuit

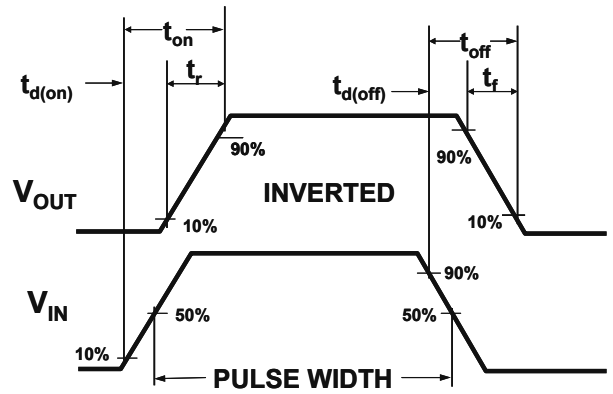

Figure 2: Switching Waveforms

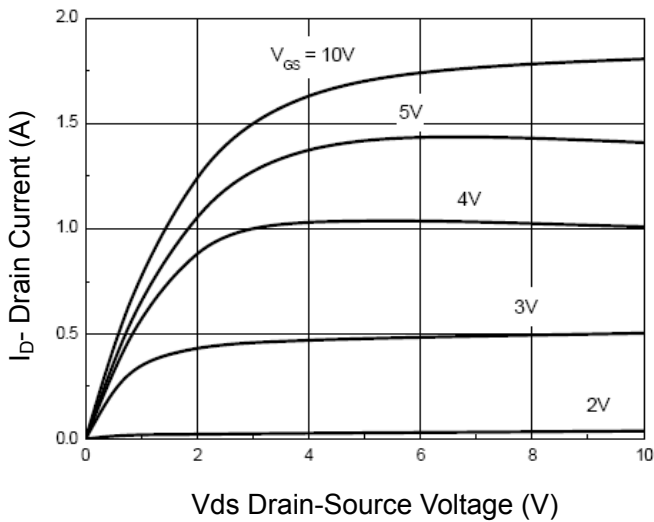

Figure 3 Output Characteristics

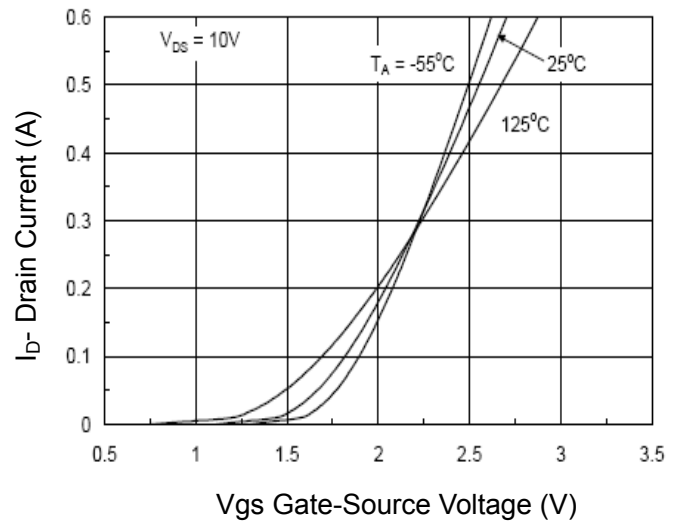

Figure 4 Transfer Characteristics

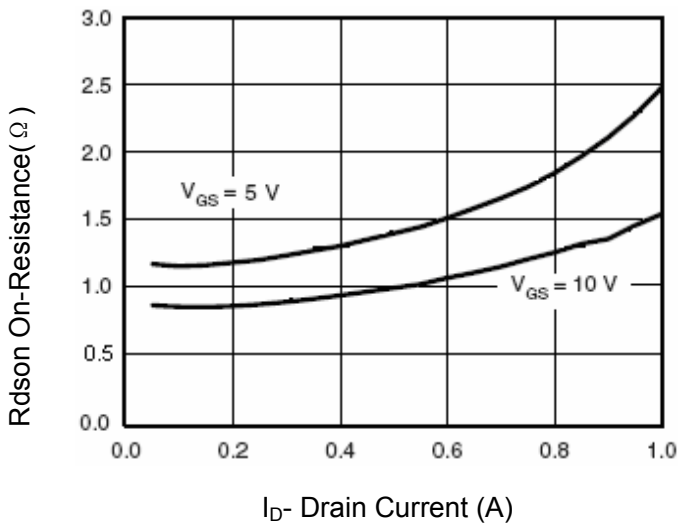

Figure 5 Drain-Source On-Resistance

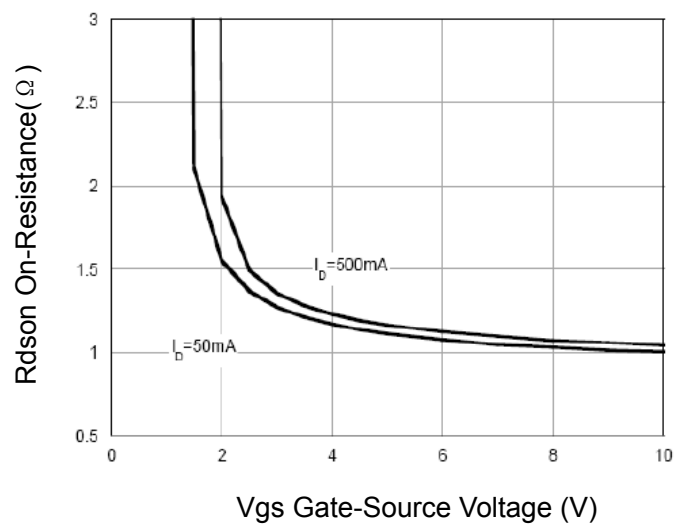

Figure 6 R_DS(on) vs V_GS

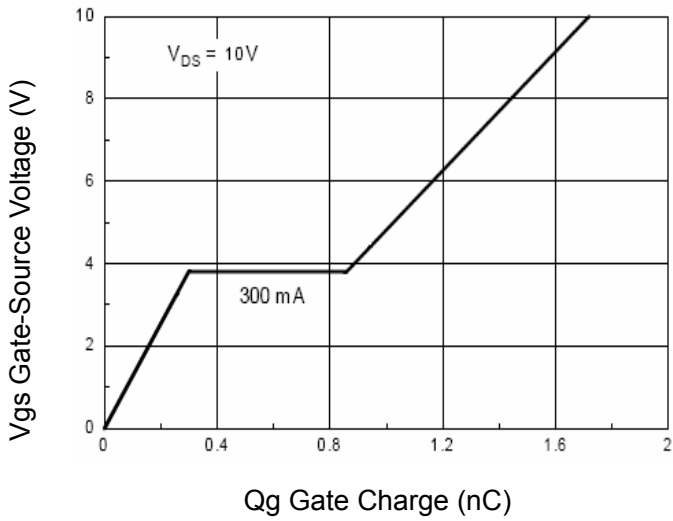

Figure 7 Gate Charge

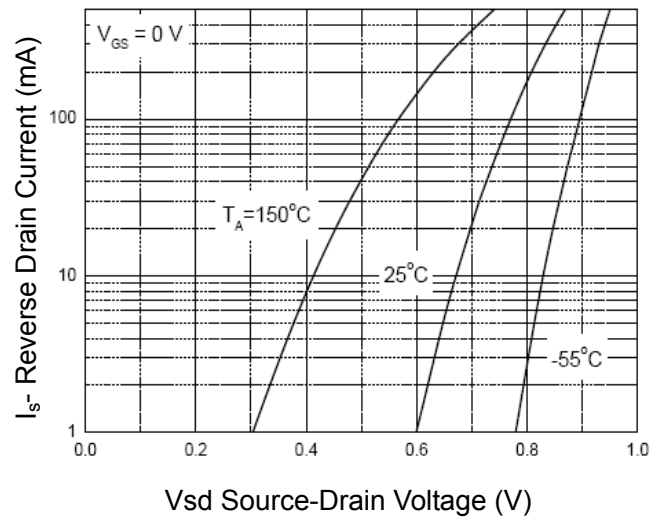

Figure 8 Source-Drain Diode Forward

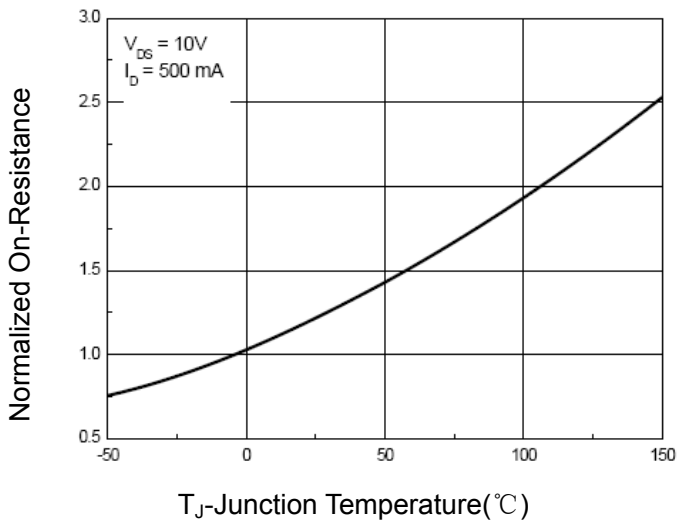

Figure 9 Drain-Source On-Resistance

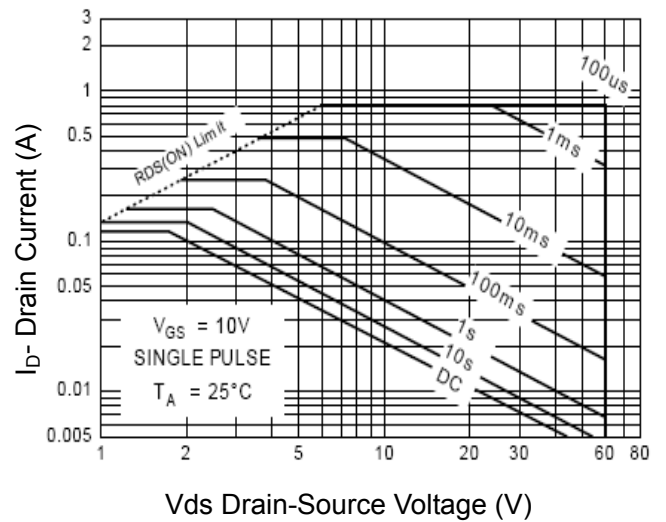

Figure 10 Safe Operation Area

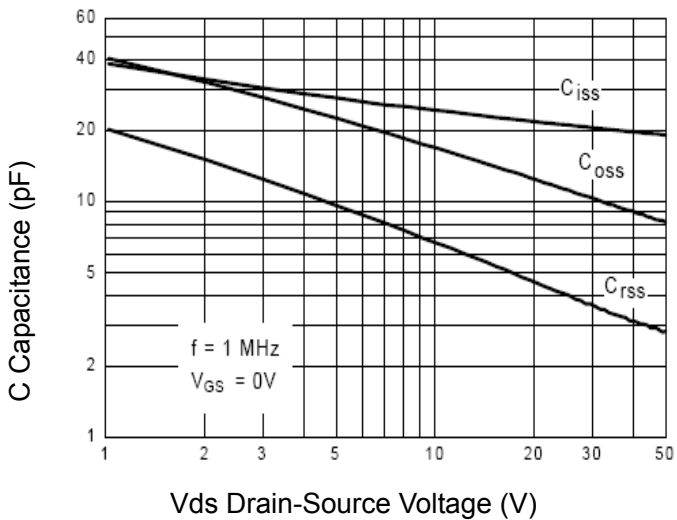

Figure 11 Capacitance vs Vds

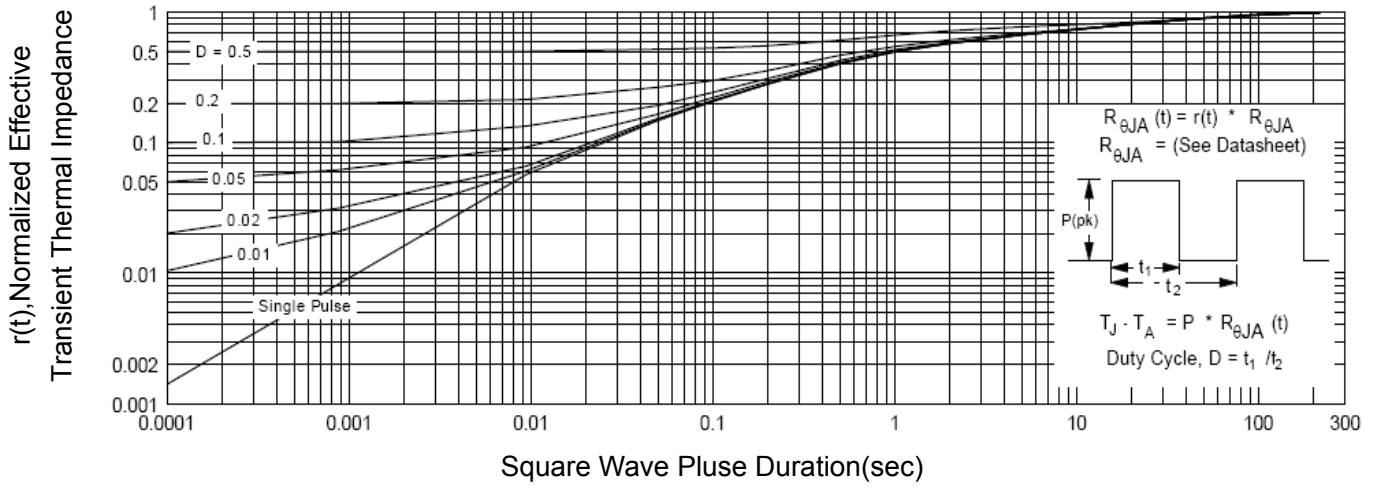
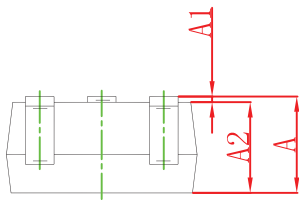
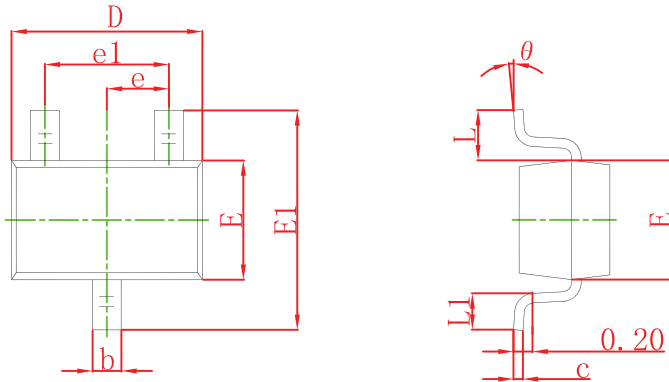

Figure 12 Normalized Maximum Transient Thermal Impedance

SOT-323 Package Outline Dimensions



Symbol	Dimensions In Millimeters		Dimensions In Inches	
	Min	Max	Min	Max
A	0.900	1.100	0.035	0.043
A1	0.000	0.100	0.000	0.004
A2	0.900	1.000	0.035	0.039
b	0.200	0.400	0.008	0.016
c	0.080	0.150	0.003	0.006
D	2.000	2.200	0.079	0.087
E	1.150	1.350	0.045	0.053
E1	2.150	2.450	0.085	0.096
e	0.650 TYP		0.026 TYP	
e1	1.200	1.400	0.047	0.055
L	0.525 REF		0.021 REF	
L1	0.260	0.460	0.010	0.018
θ	0°	8°	0°	8°

SOT-323 Suggested Pad Layout

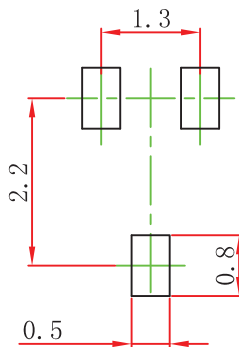

Note:
 1. Controlling dimension: in millimeters.
 2. General tolerance: ±0.05mm.
 3. The pad layout is for reference purposes only.