

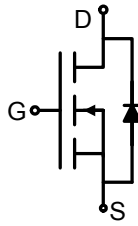
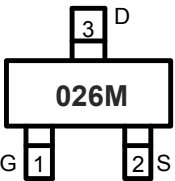

N-Channel Enhancement Mode Power MOSFET

<p><b>DESCRIPTION</b></p> <p>The HM2302 uses advanced trench technology to provide excellent <math>R_{DS(ON)}</math>, low gate charge and operation with gate voltages as low as 2.5V. This device is suitable for use as a Battery protection or in other Switching application.</p> <p><b>GENERAL FEATURES</b></p> <ul style="list-style-type: none"> <li>● <math>V_{DS} = 20V, I_D = 2.9A</math></li> <li>● <math>R_{DS(ON)} &lt; 59m\Omega @ V_{GS}=2.5V</math></li> <li>● <math>R_{DS(ON)} &lt; 45m\Omega @ V_{GS}=4.5V</math></li> <li>● High Power and current handing capability</li> <li>● Lead free product is acquired</li> <li>● Surface Mount Package</li> </ul> <p><b>Application</b></p> <ul style="list-style-type: none"> <li>● Battery protection</li> <li>● Load switch</li> <li>● Power management</li> </ul>	<div style="text-align: center;">  <p>Schematic diagram</p>  <p>Marking and pin Assignment</p>  <p>SOT-23 top view</p> </div>
---	---

Package Marking And Ordering Information

Device Marking	Device	Device Package	Reel Size	Tape width	Quantity
026M	HM2302	SOT-23	Ø180mm	8 mm	3000 units

Absolute Maximum Ratings (TA=25°C unless otherwise noted)

Parameter	Symbol	Limit	Unit
Drain-Source Voltage	$V_{DS}$	20	V
Gate-Source Voltage	$V_{GS}$	±10	V
Drain Current-Continuous	$I_D$	2.9	A
Drain Current-Pulsed (Note 1)	$I_{DM}$	10	A
Maximum Power Dissipation	$P_D$	1	W
Operating Junction and Storage Temperature Range	$T_J, T_{STG}$	-55 To 150	°C

Thermal Characteristic

Thermal Resistance, Junction-to-Ambient (Note 2)	$R_{\theta JA}$	125	°C/W
--	-----------------	-----	------

Electrical Characteristics (TA=25°C unless otherwise noted)

Parameter	Symbol	Condition	Min	Typ	Max	Unit
<b>Off Characteristics</b>						
Drain-Source Breakdown Voltage	$BV_{DSS}$	$V_{GS}=0V, I_D=250\mu A$	20	22	-	V
Zero Gate Voltage Drain Current	$I_{DSS}$	$V_{DS}=20V, V_{GS}=0V$	-	-	1	μA

Gate-Body Leakage Current	$I_{GSS}$	$V_{GS}=\pm 10V, V_{DS}=0V$	-	-	$\pm 100$	nA
<b>On Characteristics (Note 3)</b>						
Gate Threshold Voltage	$V_{GS(th)}$	$V_{DS}=V_{GS}, I_D=250\mu A$	0.5	0.75	1.2	V
Drain-Source On-State Resistance	$R_{DS(ON)}$	$V_{GS}=2.5V, I_D=2.5A$	-	37	59	m $\Omega$
		$V_{GS}=4.5V, I_D=2.9A$	-	30	45	m $\Omega$
Forward Transconductance	$g_{FS}$	$V_{DS}=5V, I_D=2.9A$	-	8	-	S
<b>Dynamic Characteristics (Note4)</b>						
Input Capacitance	$C_{iss}$	$V_{DS}=10V, V_{GS}=0V,$ $F=1.0MHz$	-	300	-	PF
Output Capacitance	$C_{oss}$		-	120	-	PF
Reverse Transfer Capacitance	$C_{rss}$		-	80	-	PF
<b>Switching Characteristics (Note 4)</b>						
Turn-on Delay Time	$t_{d(on)}$	$V_{DD}=10V, I_D=2.9A$ $V_{GS}=4.5V, R_{GEN}=6\Omega$	-	10	15	nS
Turn-on Rise Time	$t_r$		-	50	85	nS
Turn-Off Delay Time	$t_{d(off)}$		-	17	45	nS
Turn-Off Fall Time	$t_f$		-	10	20	nS
Total Gate Charge	$Q_g$	$V_{DS}=10V, I_D=2.9A,$ $V_{GS}=4.5V$	-	4.0	10	nC
Gate-Source Charge	$Q_{gs}$		-	0.65	-	nC
Gate-Drain Charge	$Q_{gd}$		-	1.2	-	nC
<b>Drain-Source Diode Characteristics</b>						
Diode Forward Voltage (Note 3)	$V_{SD}$	$V_{GS}=0V, I_S=2.9A$	-	0.75	1.2	V
Diode Forward Current (Note 2)	$I_S$		-	-	2.9	A

**Notes:**

1. Repetitive Rating: Pulse width limited by maximum junction temperature.
2. Surface Mounted on FR4 Board,  $t \leq 10$  sec.
3. Pulse Test: Pulse Width  $\leq 300\mu s$ , Duty Cycle  $\leq 2\%$ .
4. Guaranteed by design, not subject to production

TYPICAL ELECTRICAL AND THERMAL CHARACTERISTICS

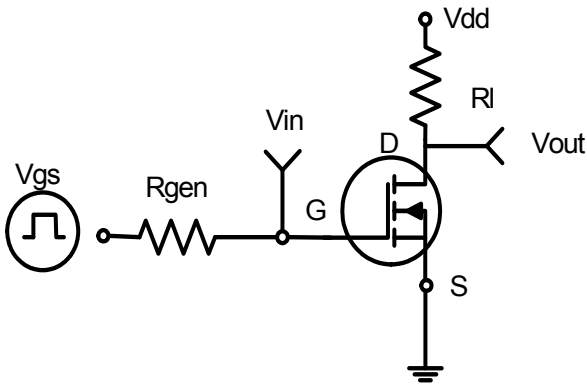

Figure 1: Switching Test Circuit

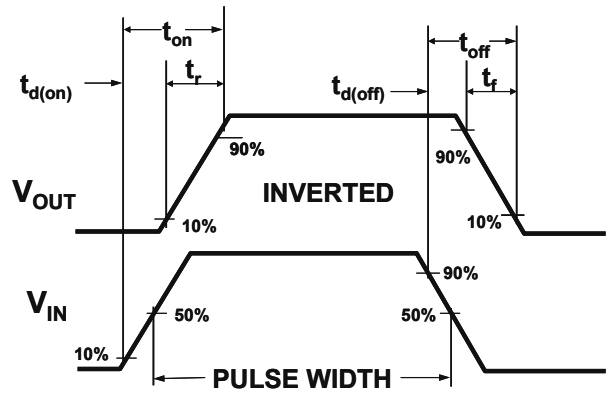

Figure 2: Switching Waveforms

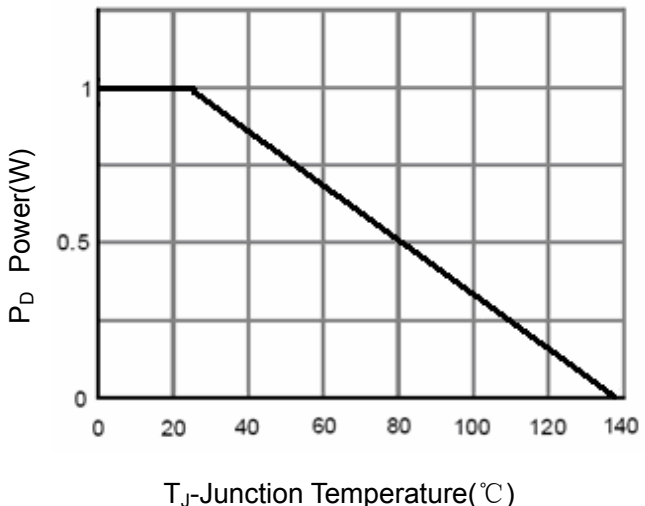

Figure 3 Power Dissipation

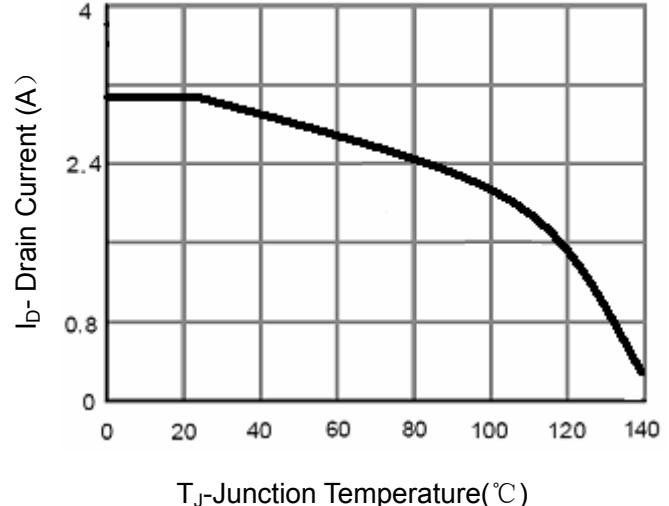

Figure 4 Drain Current

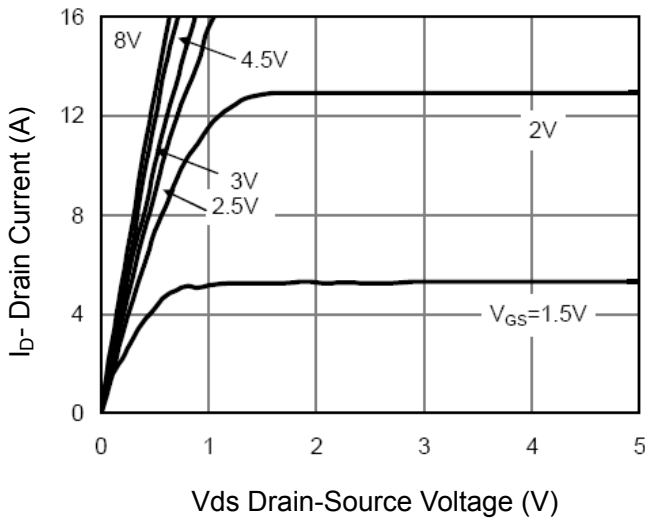

Figure 5 Output CHARACTERISTICS

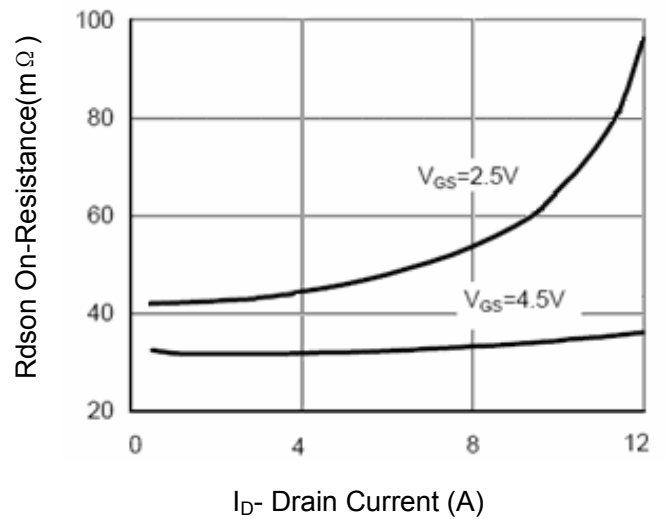

Figure 6 Drain-Source On-Resistance

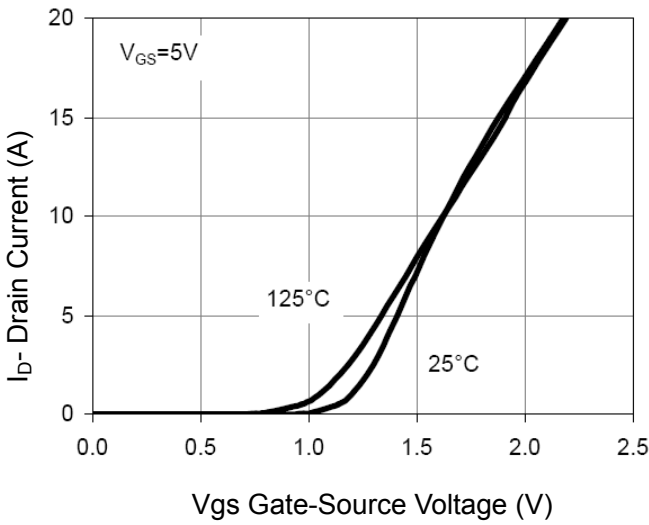

Figure 7 Transfer Characteristics

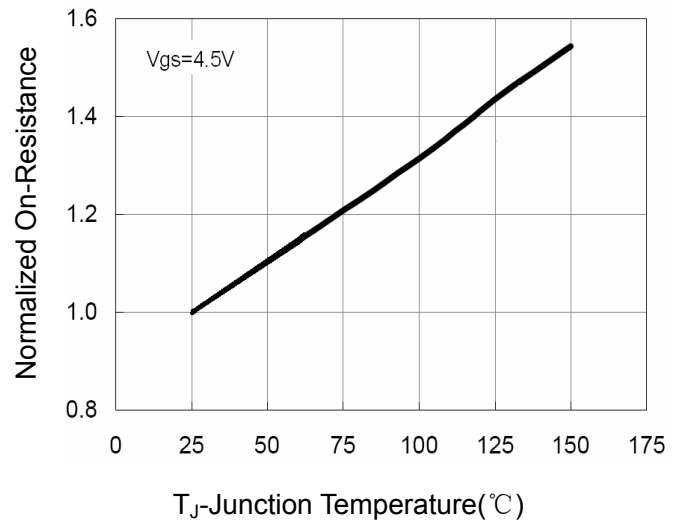

Figure 8 Drain-Source On-Resistance

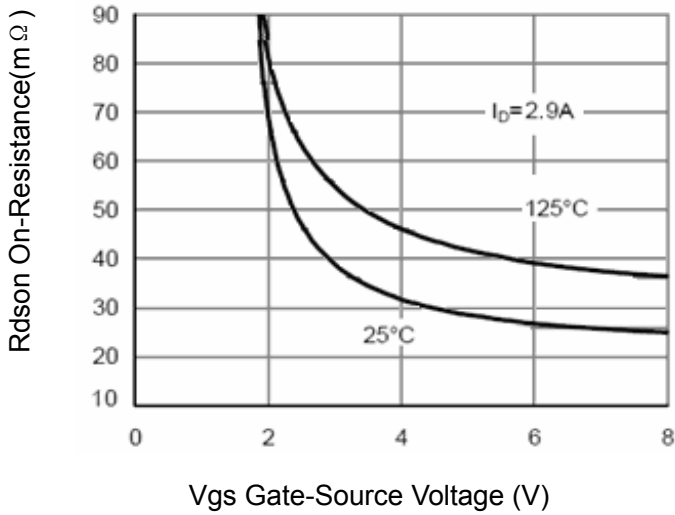

Figure 9 Rdson vs Vgs

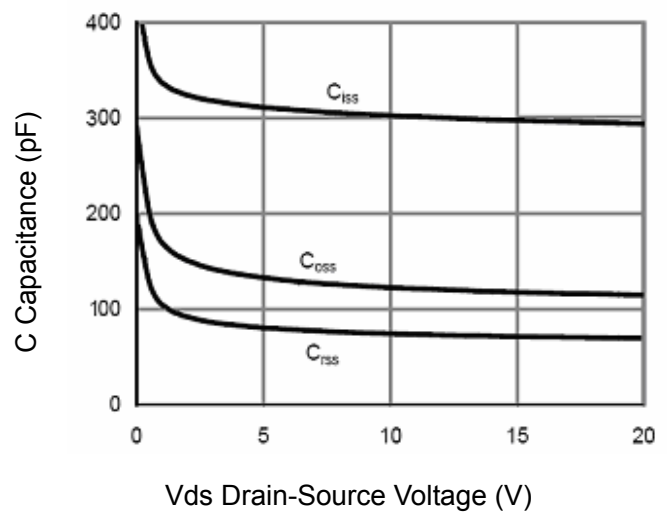

Figure 10 Capacitance vs Vds

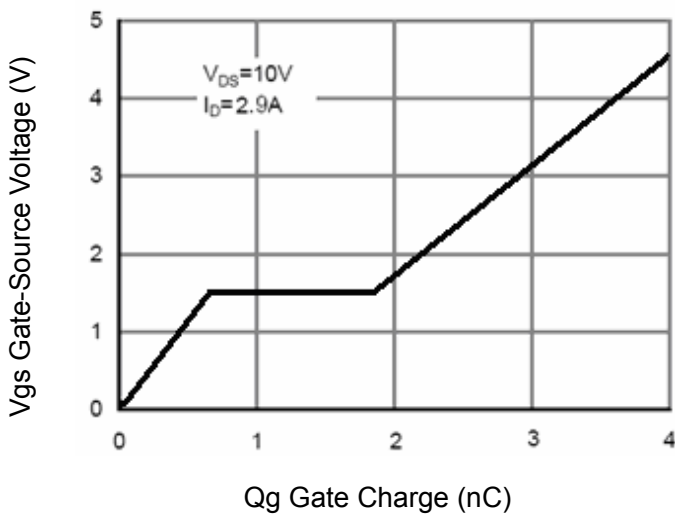

Figure 11 Gate Charge

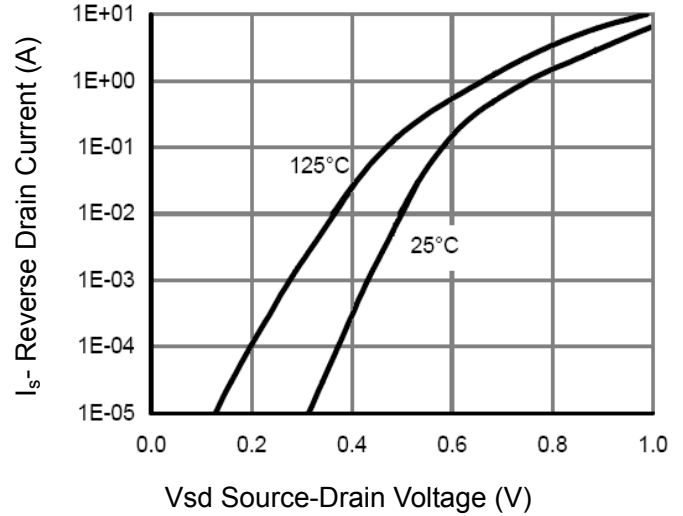

Figure 12 Source- Drain Diode Forward

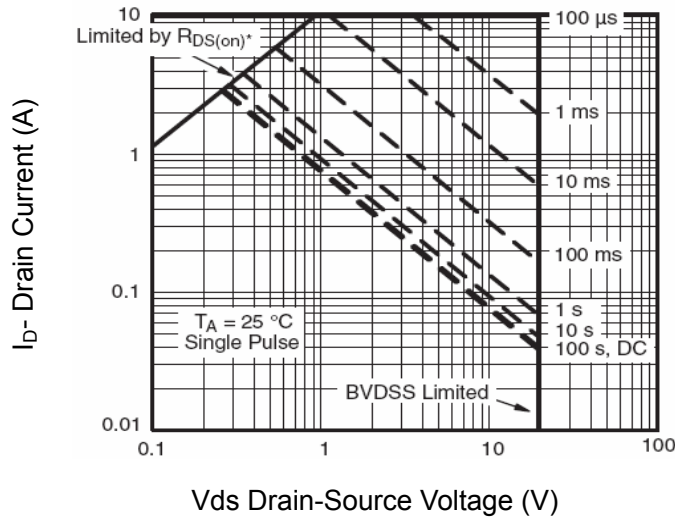

Figure 13 Safe Operation Area

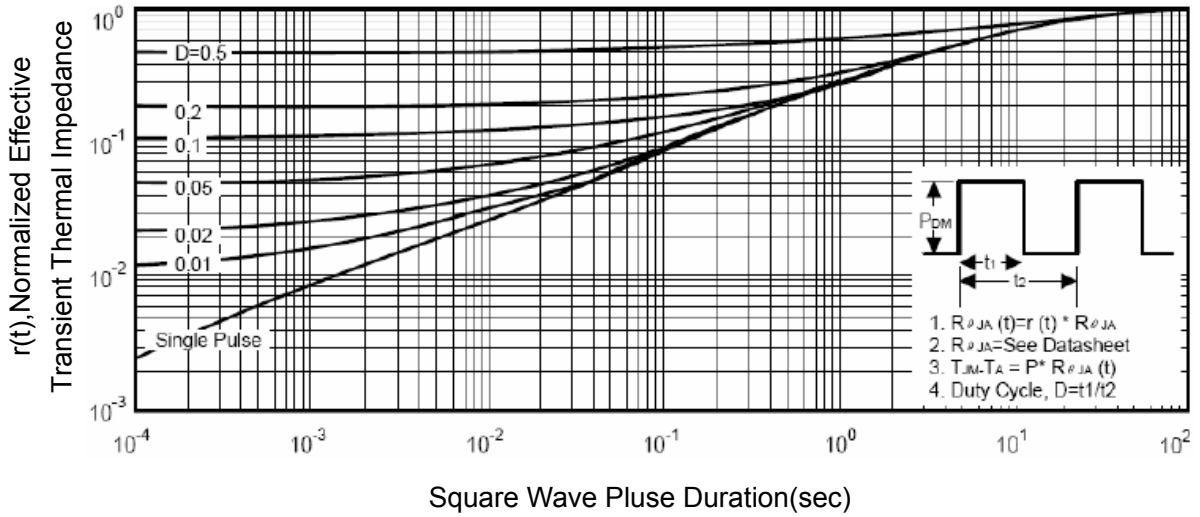
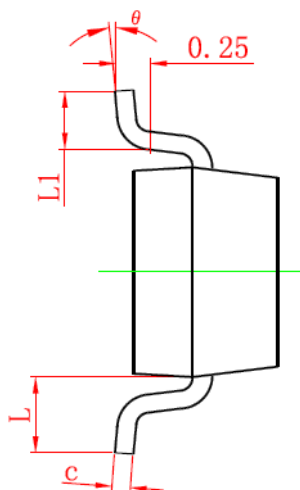
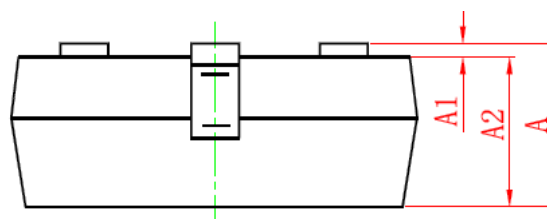
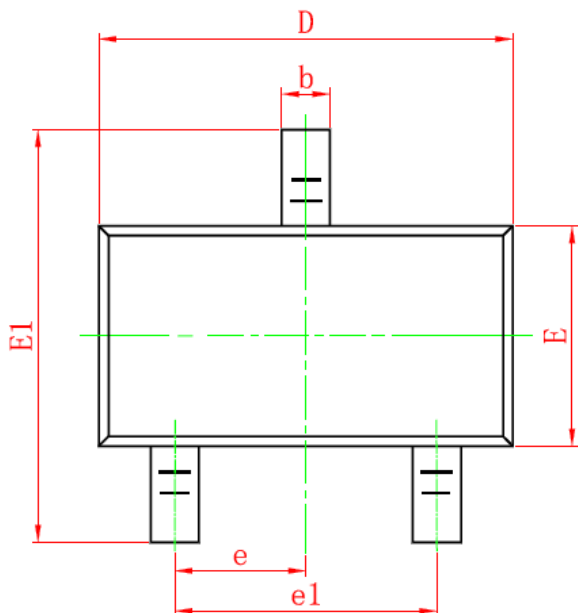

Figure 14 Normalized Maximum Transient Thermal Impedance

## SOT-23 PACKAGE INFORMATION

Dimensions in Millimeters (UNIT:mm)



Symbol	Dimensions in Millimeters	
	MIN.	MAX.
A	0.900	1.150
A1	0.000	0.100
A2	0.900	1.050
b	0.300	0.500
c	0.080	0.150
D	2.800	3.000
E	1.200	1.400
E1	2.250	2.550
e	0.950TYP	
e1	1.800	2.000
L	0.550REF	
L1	0.300	0.500
θ	0°	8°

### NOTES

- All dimensions are in millimeters.
- Tolerance  $\pm 0.10\text{mm}$  (4 mil) unless otherwise specified
- Package body sizes exclude mold flash and gate burrs. Mold flash at the non-lead sides should be less than 5 mils.
- Dimension L is measured in gauge plane.
- Controlling dimension is millimeter, converted inch dimensions are not necessarily exact.